

# KENWOOD

# TS-711A/E

## 144 MHz ALL MODE TRANSCEIVER

### INSTRUCTION MANUAL



Illustrated is the TS-711A version.

Thank you for purchasing of our latest product, the TS-711A/E transceiver. Please read this instruction manual carefully before placing your transceiver in service. The unit has been carefully engineered and manufactured to rigid quality standards, and should provide you satisfactory and dependable operation for many years.

### CONTENTS

ACCESSORIES (SUPPLIED) .....	2
FEATURES .....	2
SPECIFICATIONS.....	3
CONTROLS, CONNECTORS AND INDICATORS.....	4
OPERATION	
AUTO MODE SETTING.....	11
DIAL FREQUENCY .....	11
INITIAL FREQUENCY SETTING .....	11
CONFIRMATION BY MEANS OF BEEP SOUND .....	11
FM OPERATION.....	11
SSB OPERATION .....	12
CW OPERATION.....	13
SATELLITE COMMUNICATIONS .....	13
FUNCTION CONTROLS AND SWITCHES .....	14
DIGITAL FUNCTION .....	15
SCAN.....	15
ALERT OPERATION.....	16
DCS SYSTEM FEATURES .....	16
FIXED STATION OPERATION .....	19
MOBILE INSTALLATION [GENERAL] .....	19
MAINTENANCE AND ADJUSTMENT .....	20
TROUBLESHOOTING.....	22
ACCESSORIES (OPTION).....	23
CIRCUIT DESCRIPTION.....	25
BLOCK DIAGRAM.....	28
PLL UNIT SCHEMATIC DIAGRAM.....	29

## AFTER UNPACKING

- **Shipping container:**  
Save the boxes and packing in the event your unit needs to be transported for remote operation, maintenance, or service.
- **The following explicit definitions apply in this manual:**  
**Note:** If disregarded, inconvenience only, no risk of equipment damage or personal injury.  
**Caution:** Equipment damage may occur, but not personal injury.

## ACCESSORIES (SUPPLIED)

Carefully unpack your TS-711A/TS-711E and check that it is supplied with the following accessories:

1. Standby plug (E12-0401-15)..... 1 pc.
2. 13 pin DIN plug (E07-1351-05)..... 1 pc.
3. Wire harness kit (E31-3064-00) (for VS-1) ..... 1 pc.
4. Instruction manual (B50-4148-30)..... 1 pc.
5. AC cord (E30-1643-15) ..... 1 pc.  
(Europe) (E30-1645-05) ..... 1 pc.  
(Oseania) (E30-1647-05) ..... 1 pc.
6. Spare fuse (3A) (F05-3022-05) ..... 1 pc.  
**Note:** Units shipped to USA, Europe and Oseania are not equipped with this fuse.
7. Warranty card..... 1 pc.
- \*8. Microphone (T91-0331-05) ..... 1 pc.  
\* For the TS-711E only

## FEATURES

1. **DCS = Digital Code Squelch**  
DCS uses digital code information to open squelch on a receiver that has been programmed to accept the specific code being transmitted. The system recognizes 100,000 different 5 digit code signals, making it possible for each station to have its own "private call" code, as well as to have "group call" or "common call" code. DCS is also effective in suppressing unwanted signals.
2. **COMPACT DESIGN 144 MHz ALL MODE TRANSCIEVER** capable of AC or DC operation.
3. **HIGH STABILITY**  
Dual 10 Hz step digital VFO design, incorporating a single Temperature Compensated Crystal Oscillator for the ultimate in stability.
4. **HIGHLY VISIBLE FLUORESCENT TUBE DISPLAY.**
5. **40 CHANNEL MEMORY**  
Frequency, mode, dial data, TX offset and sub-tone data can be memorized.
6. **AUTO MODE SELECTION**  
Automatically selects the proper mode for the band segment selected.
7. **MANUAL MODE SELECTION**  
Simple pushbutton switching. The first letter of each mode is announced in Morse Code thru the built in speaker.
8. **MULTIFUNCTION MAIN TUNING DIAL**  
Easily selected continuous tuning or channelized, click-stop, type tuning is controlled by the CH.Q switch. When in Mch mode, the main dial automatically selects click type tuning.
9. **RIT CONTROL**  
+/- 9.99 kHz in 10 Hz steps is possible.
10. **MICROPROCESSOR CONTROLLED FUNCTIONS**  
SCAN: Programmable band scan, memory scan.  
AL: Priority Alert (M CH 1)  
M > V: Memory to VFO  
SPLIT: Split Frequency Operation (RXA-TXB or RXB-TXA)  
A = B: For equalizing VFOA and B  
CH. S: In VFO mode, allows main dial to select memory channel. In memory scan mode, specifies channels to be skipped.  
REV & LOCK: Locks dial mode; reverses split memory channels.
11. **MANUAL FUNCTIONS**
  - All mode squelch
  - All mode RF Power control
  - IF shift
  - Speech processor: AF speech processor for SSB and FM
  - RF ATTN: Provides approximately 20 dB of attenuation
  - CW Semi break-in: with adjustable delay
12. **SELECTED OPTIONS**  
VS-1 ..... Voice Synthesizer  
TU-5 (TS-711A) ..... Sub Audible Tone Encoder
13. **PERSONAL COMPUTER INTERFACE**  
Use of the optional interface will allow simple "basic" language programming of major functions.

# SPECIFICATIONS

## [General]

Frequency range.....	144.0 ~ 148.0 MHz..... (TS-711A) 144.0 ~ 146.0 MHz..... (TS-711E)
Radio wave mode.....	A3J (SSB), F2, F3 (FM), A1 (CW)
Antenna impedance.....	50 ohms
Operating temperature.....	-10°C ~ +50°C
Power voltage.....	AC120V/240V/220V, 50/60 Hz DC 13.8V (12V ~ 16V)
Grounding.....	Negative
Power consumption.....	170W, 6.5A (DC13.8V) at maximum transmission 50W, 1.2A (DC13.8V) in receive mode without receiving signal
Frequency tolerance (-10°C ~ +50°C).....	Within ± 3 ppM (SSB/CW) Within ± 5 ppM (FM)
Frequency stability.....	± 300 Hz 1 ~ 60 minutes after power on Within 50 Hz/every 30 minutes 60 minutes later (after power on)
Dimensions.....	W270 × H96 × D260 mm (W279 × H108 × D327 mm) – Projected parts measured.
Weight.....	7.1 kg (15.62 lb)

## [Transmitter]

RF output power.....	25 watts (One minute transmission/three minutes reception) RF output variable from approx. 2W to maximum
Modulation.....	Balanced (SSB), Reactance (FM)
Spurious radiation.....	Less than -60 dB
Carrier suppression.....	Less than -40 dB
Side band suppression.....	Less than -40 dB
Maximum frequency deviation (FM).....	± 5 kHz
Modulation distortion (FM60%).....	Less than 3% (300 Hz ~ 3 kHz)
MIC impedance.....	500 ~ 600 Ω

## [Receiver]

Circuitry.....	Double superheterodyne
Intermediate frequency.....	1st 30.265 MHz 2nd 10.695 MHz (SSB/CW), 455 kHz (FM)
Receiver sensitivity FM.....	12 dB SINAD less than 0.22 μV..... (TS-711A) 12 dB SINAD less than 0.2 μV..... (TS-711E) S + N/N more than 50 dB at 1.0 mV input
SSB/CW.....	S + N/N 10 dB less than 0.16 μV..... (TS-711A) S + N/N 10 dB less than 0.13 μV..... (TS-711E)
Receiver selectivity FM.....	More than 12 kHz (-6 dB) Less than 24 kHz (-60 dB)
SSB/CW.....	More than 2.2 kHz (-6 dB) Less than 4.8 kHz (-60 dB)
Spurious response.....	Better than 70 dB
Squelch sensitivity.....	Less than 0.16 μV (threshold)
Auto scan stop level.....	Less than 0.2 μV (threshold)
Audio output power.....	More than 2.0 watts across 8 ohms load (5% dist.)
Audio output impedance.....	8 ohms

## [DCS control]

Code.....	NRZ equal-length code
Modulation.....	MSK modulation
Frequency deviation.....	± 2.5 kHz or more ± 5 kHz or less ± 3.5 kHz Standard
Mark frequency and deviation.....	1200 Hz ± 200PPM
Space frequency and deviation.....	1800 Hz ± 200 PPM
Code transmission speed and deviation.....	1200 bits/second ± 200 PPM

**Note:** Circuit and ratings are subject to change without notice due to developments in technology.

# CONTROLS, CONNECTORS AND INDICATORS

Front Panel (Illustrated is the TS-711A)

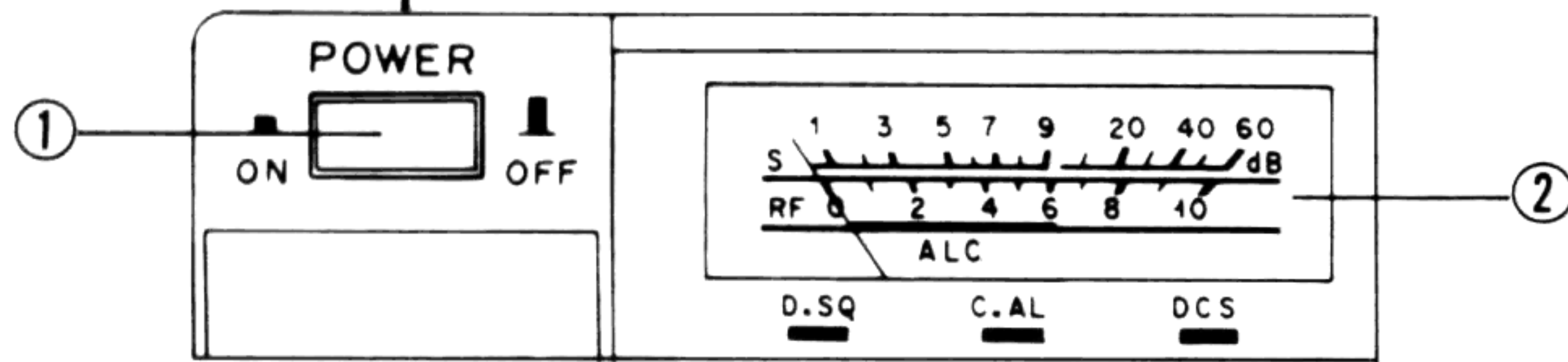
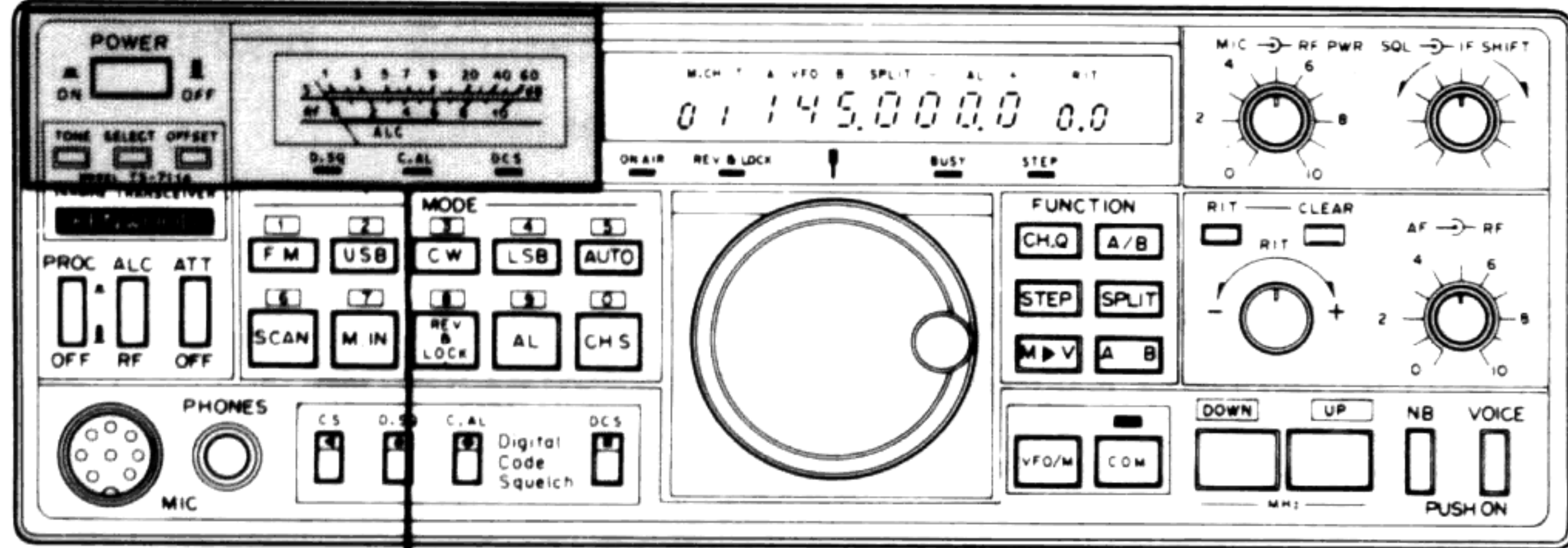

## ① POWER switch

Turns the transceiver ON and OFF.

## ② S meter

In receive mode, works as an S (signal) meter. In transmit mode, indicates RF or ALC corresponding to the ALC/RF switch setting.

In SSB/CW mode, indicates S-9 with 50  $\mu$ V input. Graduations of 9 + 20 dB, 9 + 40 dB and 9 + 60 dB are also included.

## ③ Frequency and subfunction display

- Indicates transmit and receive frequency, digital code, CALL sign (ASCII) and subtone frequency.
- Indicates memory CH number, digital code CH number and subtone CH number (Not for TS-711E).
- Indicates RIT frequency shift (-9.9 ~ 9.9 kHz) and transmit digital code CH number.
- Normally indicates MHz and kHz. When flashing, indicates scan is in operation.
- Lights when in memory CH mode.
- Lights when VFO A or VFO B is selected.
- Lights when tone is operated.
- Lights when VFOs are operated alternately or SPLIT memory CH is operated.
- Lights (-) when TX OFFSET shifts -600 kHz. Lights (+) when TX OFFSET shifts +600 kHz.
- Lights when Alert operation is set.
- Lights when the RIT switch is set to ON.

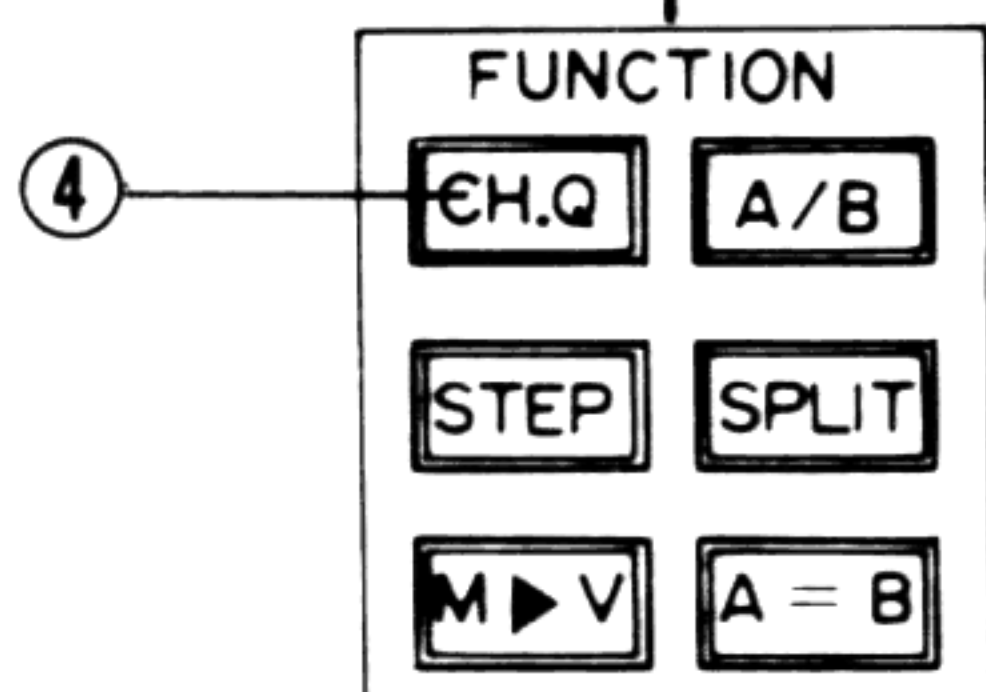
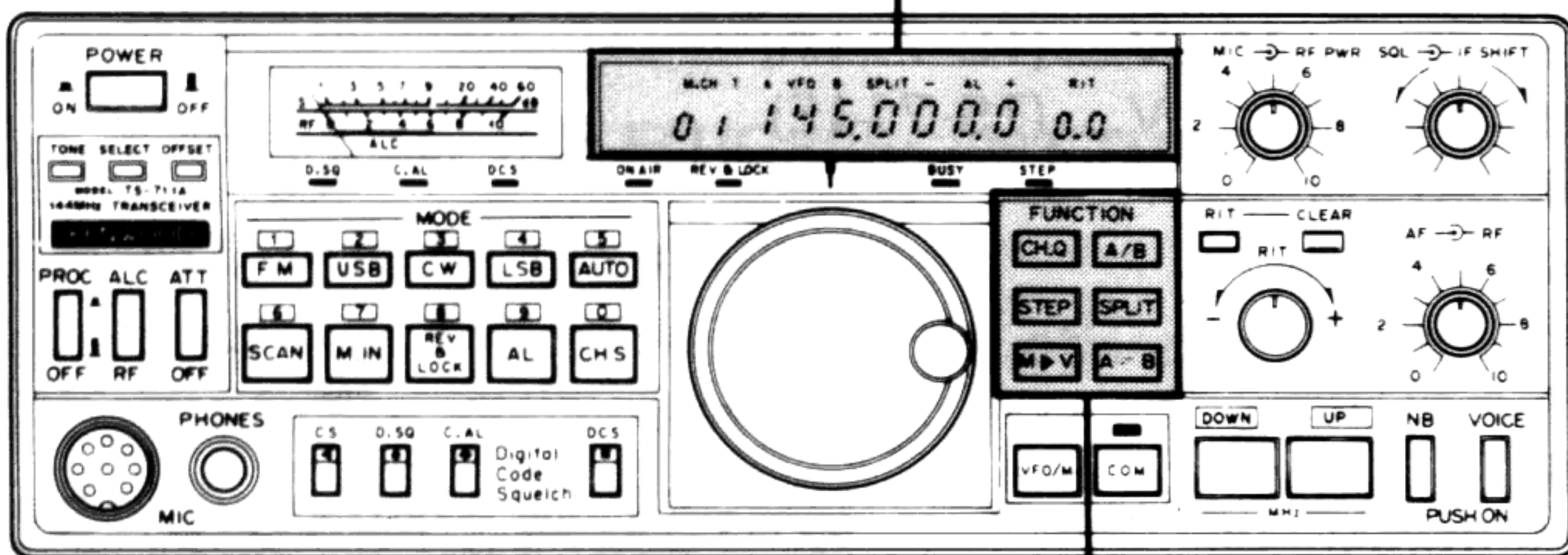
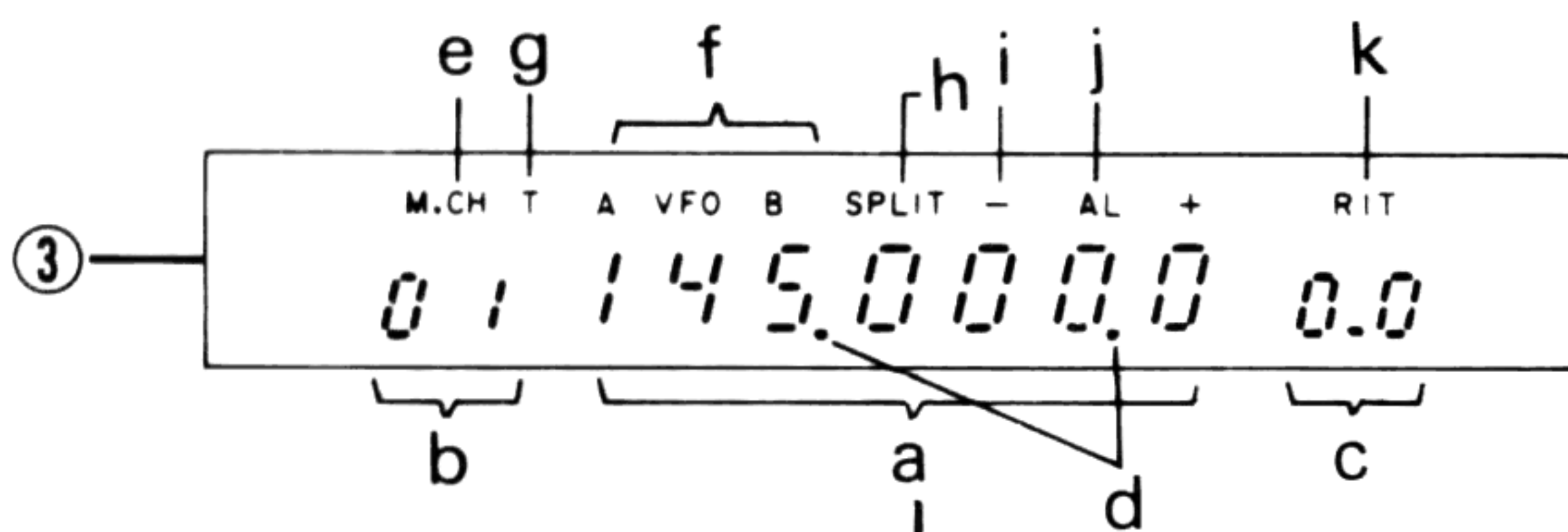

## ④ CH.Q switch (Channel QSO abbreviated)

When in the VFO mode this switch selects either "channelized" (click type) or continuously variable tuning on the Main Dial. When in the M (memory) mode channelized tuning is always selected.

VFO step

CH.Q \ Mode	FM	SSB/CW	Main dial rotation
CH.Q ON	5 kHz *12.5 kHz	5 kHz	Click
CH.Q OFF	10 Hz	10 Hz	Through

\* For units designed for use in European countries.

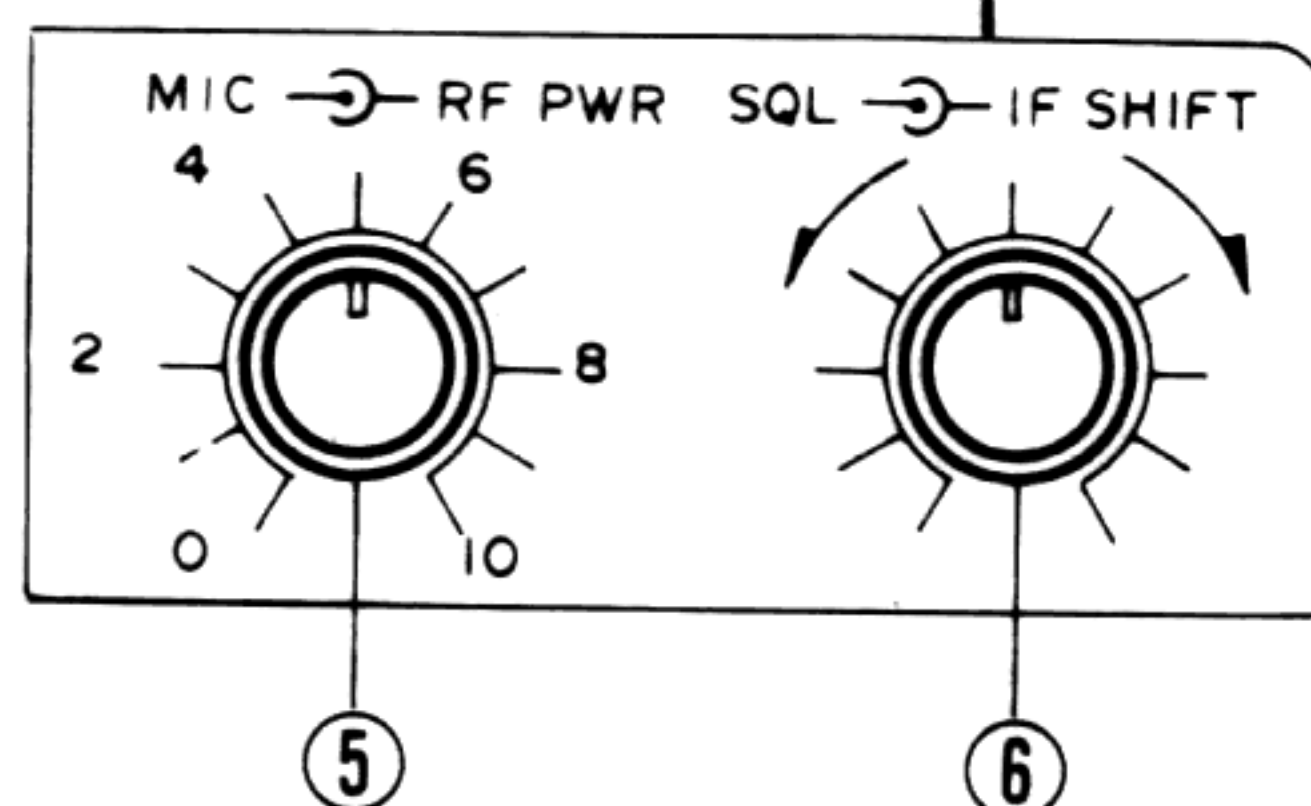
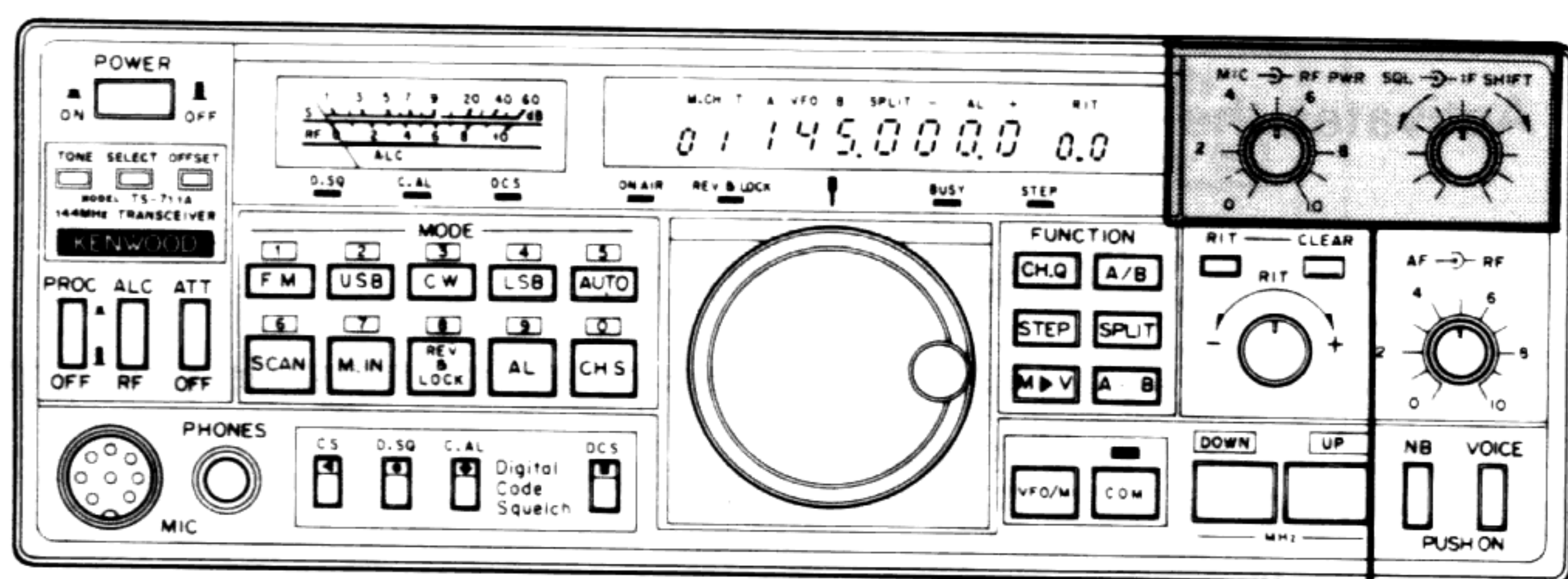

### ⑤ MIC — RF PWR controls

- MIC: In SSB mode, adjusts mic gain. Adjust for an on scale reading on voice peaks.
- RF PWR: Controls RF power continuously. Full clockwise rotation provides rated output. Counterclockwise rotation reduces RF power to approx. 2W.

### ⑥ SQL — IF.SHIFT controls

- SQL: All mode squelch control. Normally, set this control to the position where the background noise is eliminated and the BUSY indicator goes off.
- IF SHIFT: In SSB/CW receive mode, used to eliminate interference caused by adjacent channels and control the received audio quality. Normally, leave this control at the center, click, position.

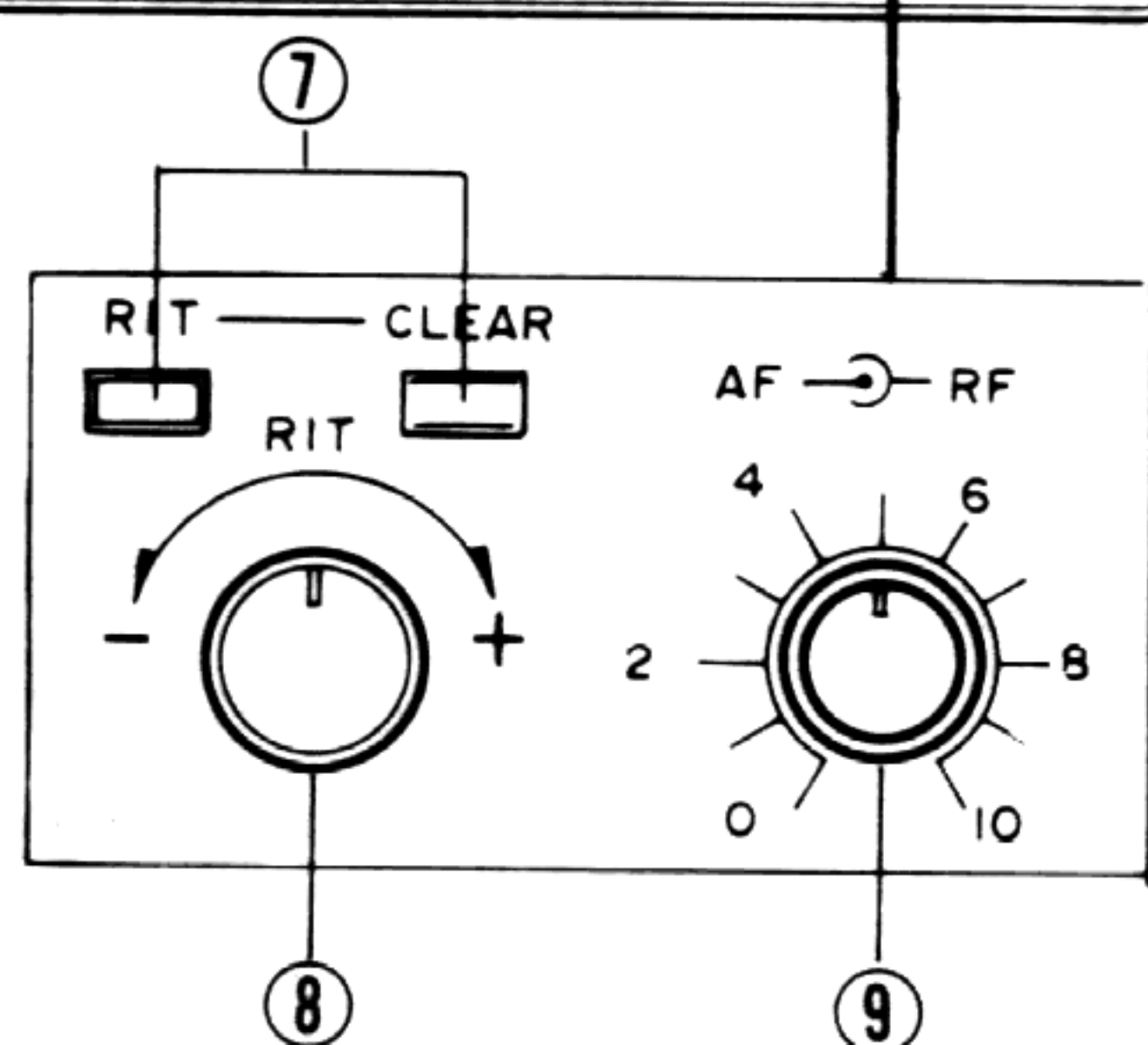
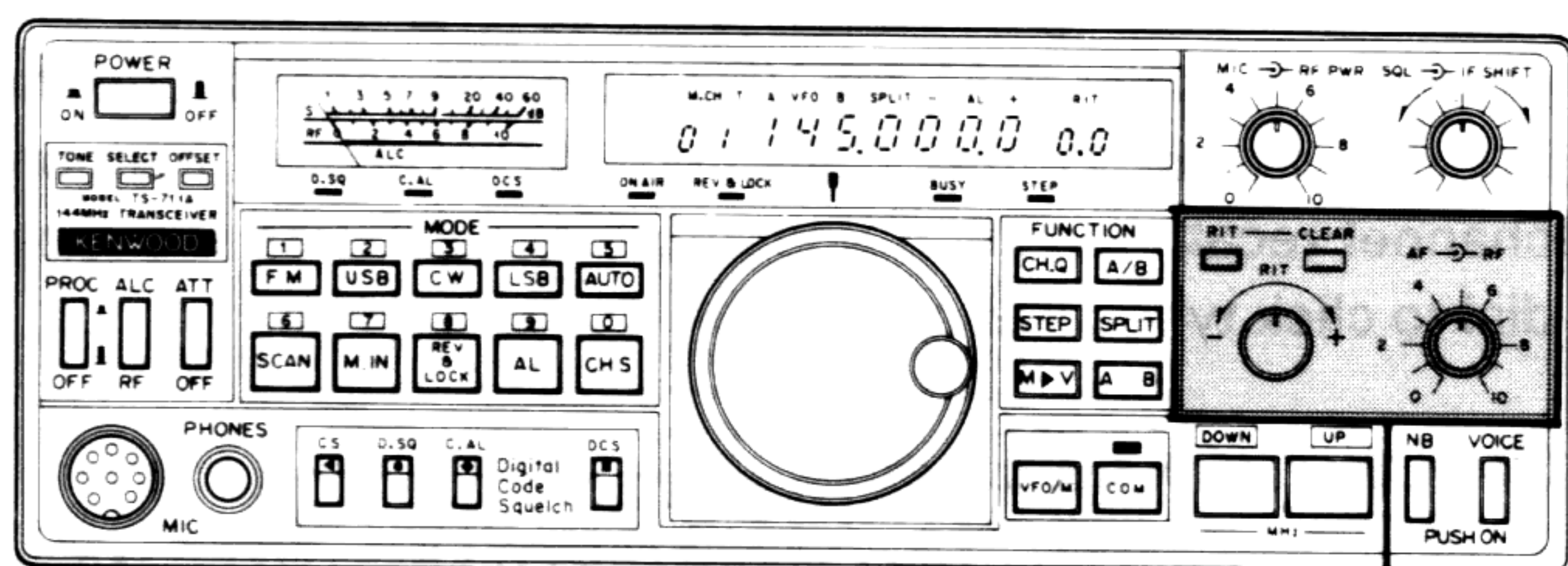

### ⑦ RIT/CLEAR switches (built-in indicators)

- RIT: Used to turn the RIT circuit ON and OFF. Setting to ON lights RIT on the display.
- CLEAR: Used to zero the RIT.

### ⑧ RIT control

Shifts only receive frequency, in 10 Hz steps, within the range  $\pm 9.99$  kHz. With the RIT switch ON, the display indicates the amount of RIT shift and also changes the main frequency display. With the RIT switch OFF, used for RIT preset. The RIT circuit is active in any mode; even in COM CH mode, and in locked-dial mode.

### ⑨ AF — RF controls

- AF: Used to control audio output level while receiving. Clockwise rotation increases sound output. Adjust the control to the desired level.
- RF: Used to adjust RF gain. Maximum gain is obtained with full clockwise rotation. As the control is rotated counterclockwise, the RF gain decreases. In normal operation, set full clockwise. Note the RF control works only in SSB/CW modes.

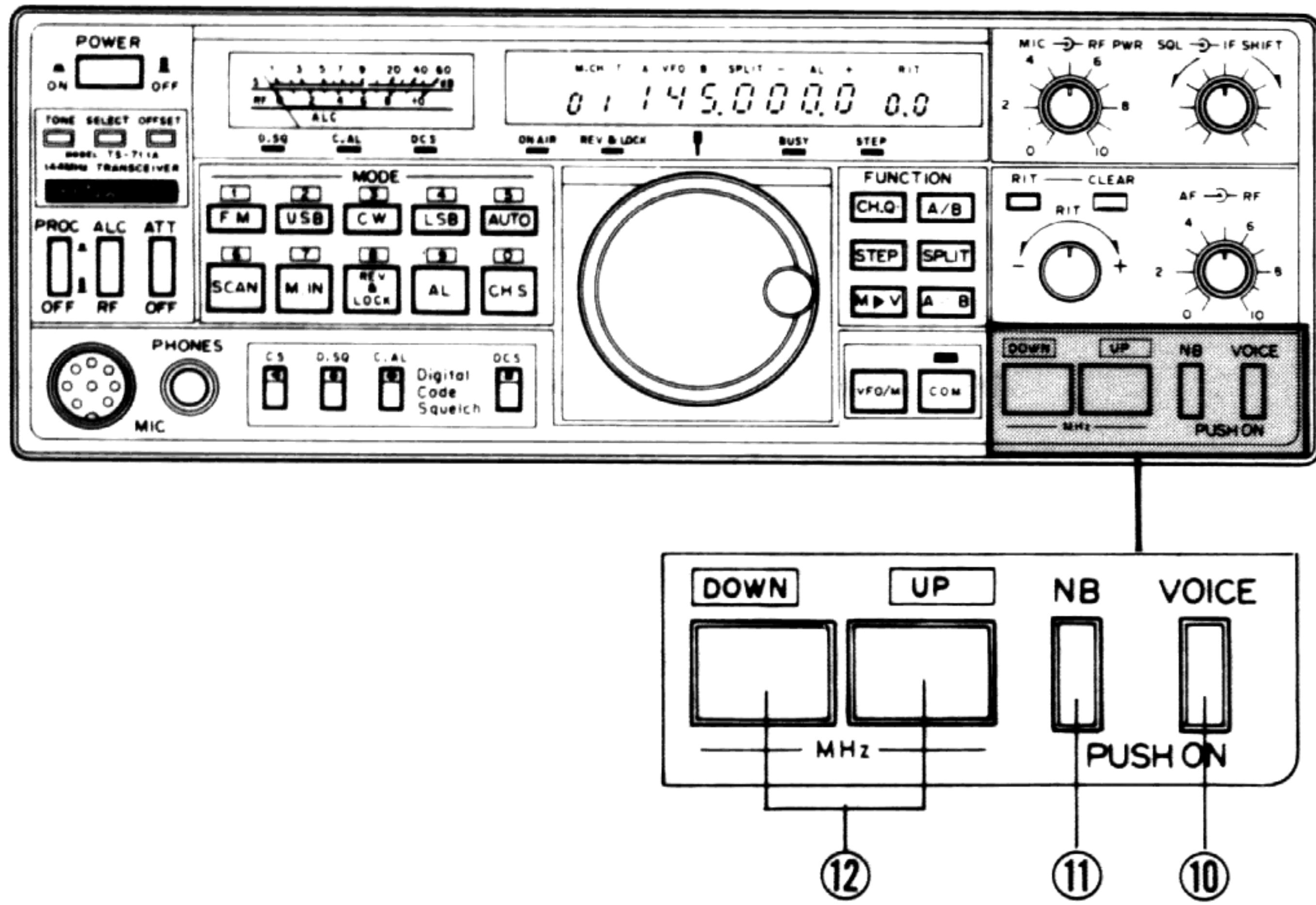

**⑩ VOICE switch**

Activates the optional voice synthesizer (VS-1).

**⑪ NB switch (Noise Blanker)**

Used when mobile ignition noise or pulse noise is present. Works in SSB/CW mode.

**⑫ DOWN/UP switches**

Shifts the frequency up or down in 1 MHz steps. Holding the switch depressed shifts the frequency downward or upward rapidly.

**⑬ COM switch**

145.000 (FM mode) is preset for COM channel. To recall the COM channel simply press "COM". The data can be changed. (See "Memory Entry")

**⑭ VFO/M switch**

Used to switch between VFO and memory channel. In the VFO mode setting, either VFO A or VFO B will be displayed. When set to M, the VFO indicator goes off and the M.CH indicator lights. Selecting M.CH allows memory channel recall operation and automatically sets the main dial to click type rotation.

**⑮ FUNCTION switches**

- **A/B** Switches VFO A and VFO B alternately. When selecting COM channel or M.CH channel operation, this switch memorizes the current frequency VFO for future recall. This is useful for memorizing SPLIT frequencies.
- **STEP** Switches the frequency step. When used in conjunction with the CH.Q switch, this switch sets the following step sizes:

Mode CH.Q Step	FM		SSB/CW	
	OFF	ON	OFF	ON
OFF	10 Hz	5 kHz *12.5 kHz	10 Hz	5 kHz
ON	100 Hz	5 kHz	100 Hz	1 kHz

\* For units designed for use in European countries.

- **SPLIT** Allows split frequency operation. The VFO displayed in Rx is the receive VFO. For example: 146.000 is in VFO A. 146.750 is in VFO B. VFO A is displayed in RX. The RX frequency is therefore: 146.000 and the TX frequency is 146.750. (A-Rx and B-Tx). If B was the active VFO B-Rx and A-Tx.

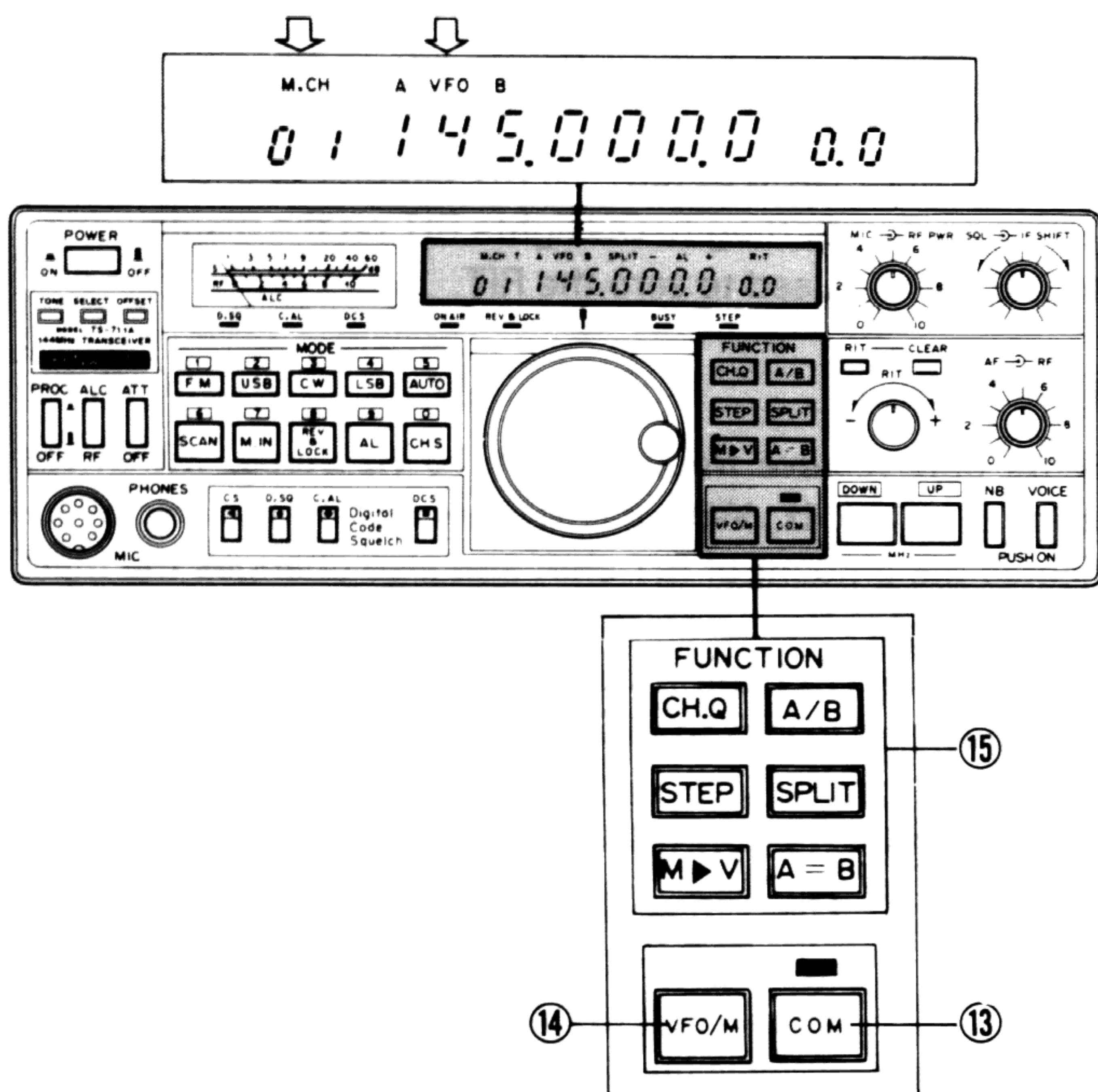

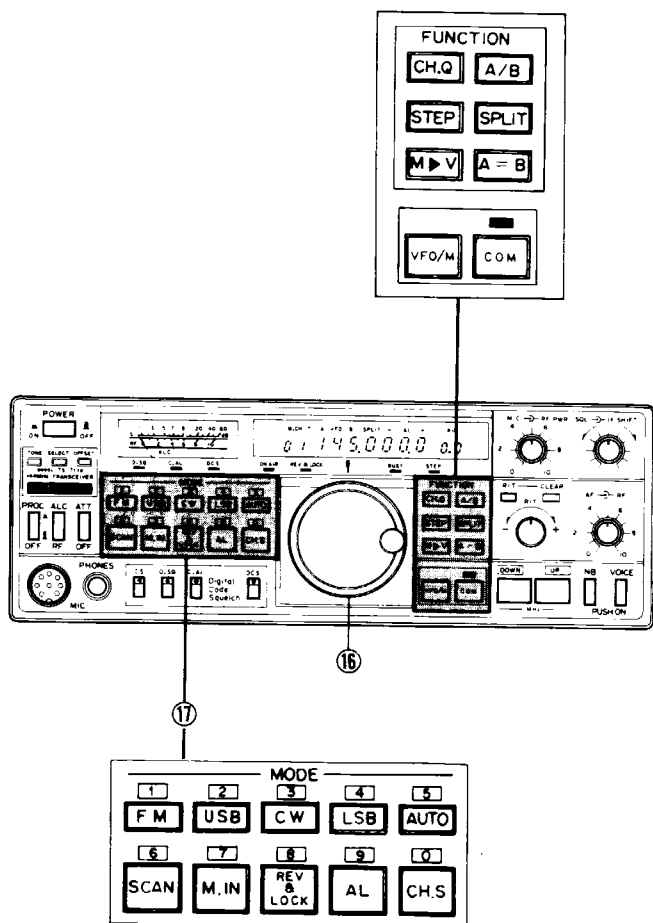

- **A=B** Used to equalize all data (frequency, mode, RIT setting, OFFSET, AL, T and SPLIT).
- **M▶V** Switches all data from memory channel to VFO. Also, switches from COM channel to VFO.

**16 Main dial control**

- In VFO mode: Used to set frequency.
- In M.CH mode: Used to select memory channel from 01 through 40 by click type rotation.
- In CS mode: Used to select digital code channel from C0 through C9 by click type rotation.

- In TONE SEL mode: Used to select subtone frequency 01 (67 Hz) through 37 (250.3 Hz) by click type rotation.

\* For the TS-711A only

- When the main dial is in continuous tune mode, rapidly rotating the dial will automatically select the increased step size.

**17 MODE/keys (1 ~ 0)**

FM, USB, CW, LSB: Used to select the desired mode. When pressed, initial letter of mode is announced by morse code thru the speaker.

- **AUTO** Used to switch mode automatically in conjunction with the frequency range selected. The mode change is announced by single beep.
- **SCAN** Used to activate and stop scan. To stop scan, any of the ten keys can be used. Before initiating scan, the SQL control must be set to the threshold point. The scan will stop at a busy station (busy-scan). The scan is time-operated (T/O scan), so that the scan resumes after an 6 seconds delay at the busy station. In the FM mode, the scan stops at the center frequency. (center stop function)
- **M.IN** Used to store data in memory channel. Storable data are: Frequency; mode; dial click; offset; and tone frequency (TS-711A only). (See page 14.)
- **REV & LOCK** Used to lock frequency out of dial and keyboard operation. However, the RIT circuit can be operated. Pressing the REV & LOCK switch lights the REV & LOCK indicator.

Memory channels 36, 37 and 38 are for ODD SPLIT memory channels. When the REV & LOCK switch is depressed in these memory channels the Tx and Rx frequencies will be reversed.

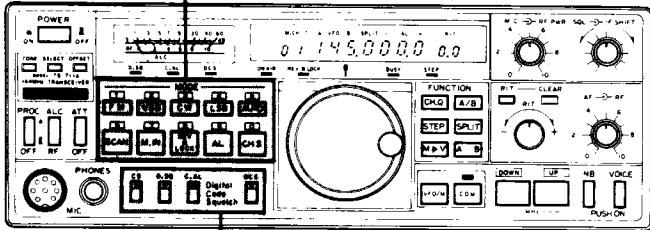
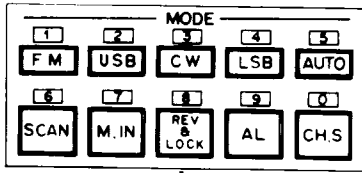

18

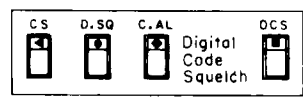

- **AL** Used to activate alert circuit to monitor memory channel 1 (M.CH 1). Turning the switch ON lights the AL indicator. Press the switch again to turn the alert circuit OFF.

- **CH.S** (Channel Select abbreviated) Allows selection of the desired memory channel while in the VFO mode. Storing memory data (pressing M.IN will release the CH.S function. In M.CH operation selects the memory channels to be locked out during memory scan. Pressing CH.S will cause a decimal point to appear to the RIGHT of the CH# indicator, as a visual indication of LOCK OUT.

In AL operation – Setting the CH.S to ON, the memory channel reverts to that of M.CH 1.

- **1 – 0** Turning ON the CS switch sets the keys to function as (1 – 0).

### 18 DCS (Digital Code Squelch)

**Note:** The DCS functions only in FM mode.

- DCS switch: Used to activate the DCS system. The DCS indicator lights when the switch is ON.
- D.SQ switch: Used to select digital code squelch ON/OFF status, or watch/nonwatch status of digital code channel.

① CS switch OFF – The DCS indicator lights to show the DCS watch mode. When the proper DCS signal is received, the squelch opens and the D.SQ indicator goes off.

② CS switch ON – Used to select the digital code channel watch status (dot on bottom right).

- C.AL: Turns the code alert ON and OFF. With this switch set to ON, the indicator lights.

① ON – When the digital code squelch is opened, a triple beep will sound continuously, until reset.

② OFF – When the digital code squelch is opened, triple beep will sound one time.

③ CS switch ON – When C- is displayed, the 1st 3 characters of the call sign are entered. When C= is displayed, the last 3 letters of the call sign are entered.

Call sign example: WD6DJY

C-: WD6, C=: DJY

- CS switch: Code switch. Used when setting digital codes, switching digital code channels, or entering a call sign. When the CS switch is ON, digital codes are entered using the 1 – 0 keys. Digital codes C0 – C9 may be selected by the main dial with the CS switch ON.



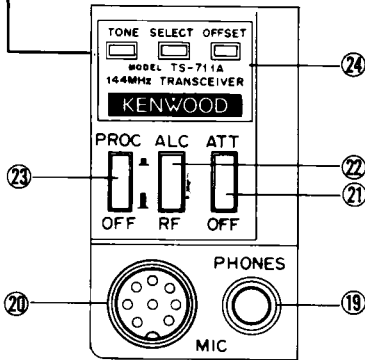
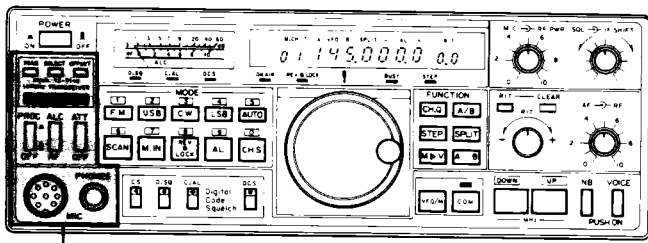

**Note:**  
Do not short or apply external voltage to pin 5.

**CAUTION:**  
Do not apply external voltage to these terminals, or damage will result.

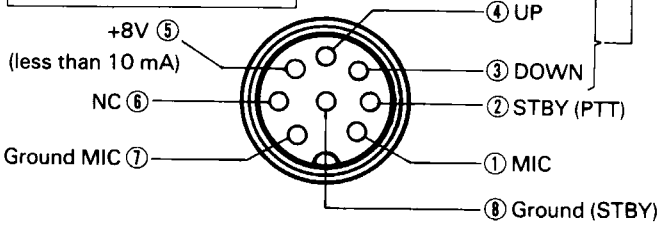

MIC connector  
< Front panel view >

**19 PHONE jack**

The headphone jack allows use of a 8 to 16 ohm headphone through a 1/4" phone plug. When phones are used the speaker is disconnected.

**20 8-pin MIC connector**

Impedance is 500 – 600 ohms. The connector consists of frequency up/down shift input terminal, terminal for the PTT, and 8 V terminal. When using a microphone other than the one specified, connect the ground of the microphone unit to pin 7 and the ground of the standby circuit to pin 8. A microphone which has a common ground for microphone unit and standby circuit cannot be used.

**21 ATT attenuator switch**

By pressing this switch approx. 20 dB of attenuation is inserted into the antenna circuit of the receiver to reduce interference caused by other services.

**22 ALC/RF switch**

Used to select RF meter or ALC meter. Pressing this switch selects ALC meter.

**23 PROC switch**

Used to increase average modulation ratio in FM mode and to increase talk power in SSB mode.

**24 RPT switch**

- TONE: Activates tone circuit. The T indicator lights.
- TONE: (For British version)  
When this switch is pressed, the repeater control tone burst signal (1,750 Hz) is emitted for about 1 seconds at the beginning of each transmission.
- TONE: (For European version)  
When this switch is pressed, the repeater control tone signal (1,750 Hz) circuit is activated and the unit is set in the transmit mode.

- \*SELECT: Indicates subtone frequency on the display. Any one of 37 CH's (67 Hz – 250.3 Hz) can be selected by the main dial. By pressing the switch again, the display returns to frequency mode. Used as a tone encoder when the optional TU-5 is installed.

\* SELECT is not applicable to European users.

- OFFSET: Used to select TX OFFSET  $\pm$  600 kHz. The indicator shifts in the following sequence (+, -, s, +, ...). However, on the display, the letter "S" indicating simplex mode will not be indicated.

**Note:**  
Although OFFSET indicator can be lighted in both SSB and CW modes, the shift operation does not work actually. OFFSET operation is available in FM mode only.

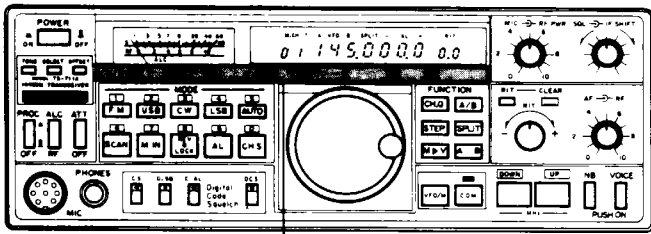

**25 Indicators**

- Ⓐ STEP: Lights when the STEP switch is ON.
- Ⓑ BUSY: Lights when the center signal is received with the SQL switch ON.
- Ⓒ REV & LOCK: Lights when the REV & LOCK switch is ON.
- Ⓓ ON AIR: Lights when transmitting.
- Ⓔ DCS: Lights when the DCS switch is ON.
- Ⓕ C.AL: Lights when the C.AL switch is ON.
- Ⓖ D.SQ: Lights when the D.SQ switch is ON.

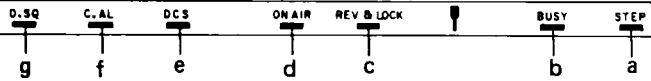

**REAR PANEL**

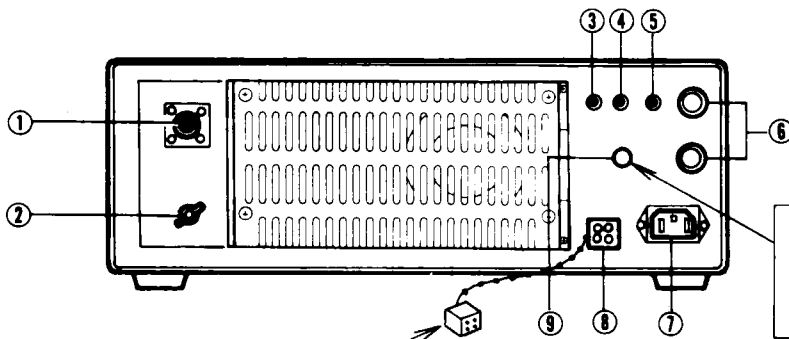

**Note:**  
When changing the voltage setting, be sure to use the correct fuse:  
● 2A fuse for 120V  
● 1A fuse for 220V/240V

**Note:**  
When operating by AC line source, be sure the dummy plug (8) is connected to its jack, otherwise the transceiver is not turned on.

**① ANT jack**

M type antenna jack of 50 ohm impedance.

**② GND terminal**

Connect a good earth ground to this terminal.

**③ EXT. SP jack**

For connecting an external 8-ohm speaker.

**④ ST BY switch**

When using an external standby switch, use the supplied plug.

**⑤ KEY jack**

For connecting a CW key. Use the supplied plug.

**⑥ ACC2 jack**

For connecting data communication devices such as

RTTY, etc. (For details, see page 21.)

**ACC1 jack**

For connecting a computer interface. (For details, see page 21.)

**⑦ AC receptacle**

AC line input. Use the supplied cable.

**⑧ DC receptacle**

For connecting a DC power source. Remove the dummy plug and plug in the optional DC cable. Observe polarities when connecting.

**⑨ Voltage selection switch**

Allows selection of three different voltages, 120V, 220V and 240V.

# OPERATION

## ■ AUTO MODE SETTING

Automatically selects the proper mode, for the frequency segment selected. See chart below.

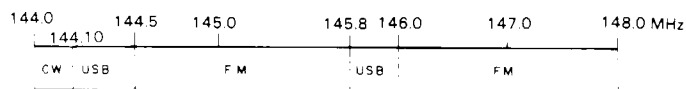

TS-711A

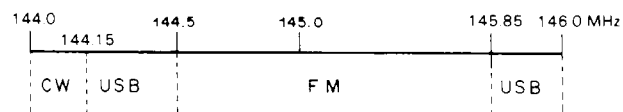

TS-711E

### Notes:

1. To release auto mode operation, press any key other than the AUTO key.
2. In AUTO mode operation, frequency cannot be changed during transmission (No. TX QSY). If the frequency is to be changed during transmission, such as in satellite communications, Release AUTO mode first.

## ■ DIAL FREQUENCY

1. The frequency displayed is the center for carrier frequency. When switching needs the display will not shift frequency, thus the displayed frequency is the actual transmit frequency.
2. In CW operation, the displayed frequency is the transmit frequency. The actual receive frequency is 800 Hz below the transmit frequency.

## ■ INITIAL FREQUENCY SETTING

When the backup battery is replaced or the microcomputer is reset, frequencies are preset as shown in the table below.

VFO A	144.000	AUTO CW	Dial click
VFO B	144.000.0	AUTO CW	Dial through
COM	145.000	AUTO FM	
Mch 1	144.000	AUTO CW	
Ch2 ~ Ch40	-----	FM	

## ■ CONFIRMATION BY MEANS OF BEEP SOUND

Audio feedback in the form of a series of beeps confirms various input functions. See Chart below for additional information.

Types of beep	When beep sounds
Single beep	Confirm key input.
Double beeps	When Mch 1 is busy in alert mode.
3 beeps	When operation fails.
4 beeps repeated	Beep sounds until transmit freq. for split operation is stored.
5 beeps	When operating another keys with REV & LOCK on.
8 beeps	When waiting memory entry.
Approx. 1.5 second beeps	When memory data is entered.

Beep also sounds when DCS is operated. (Refer to DCS operation.)

## ■ FM OPERATION

After the AC cable, antenna and microphone are connected, proceed as follows:

### Initial Switch Settings

Power switch:	OFF
MIC control:	10 o'clock position
RF PWR control:	Fully clockwise
SQL control:	Fully counterclockwise
IF SHIFT control:	12 o'clock position (click)
AF control:	Fully counterclockwise
RF control:	Fully clockwise

### < Receive operation >

1. Set the POWER switch to ON. The meter and display are illuminated. The FM, AUTO and BUSY indicators light.
2. Pressing the CHQ key generates a mechanical noise. When rotating the main dial, the rotation is felt as either click or through. Press the CHQ key so that the main dial is set to click type rotation.
3. Turn the AF control clockwise to adjust audio level to the desired level.
4. Select a clear channel with the main dial and adjust the SQL control to the threshold point (the point which noise just disappears and the BUSY indicator goes off.)

- Select the desired frequency with the main dial. When a signal is received, the S meter will deflect and the BUSY indicator will light.
- When there is interference in reception, caused by other stations, set the ATT switch to ON and the receive gain is lowered approx. 20 dB. This may improve audibility.

**Note:**

The BUSY indicator will light within the center frequency range of  $\pm 2.5$  kHz. When the frequency of the other station drifts, the audio signal will be distorted and the BUSY indicator does not light.

Therefore, frequency drift of other station and incorrect tuning of your station can be determined by this BUSY indicator.

< **Transmit operation** >

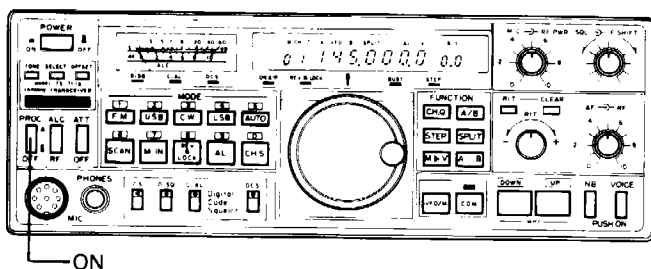

- Before transmitting, make sure the antenna connected is of 50-ohm impedance.
- Be sure not to transmit if the frequency is occupied.
- Pressing the PTT switch of the microphone allows transmission. The ON AIR indicator will light and the meter will indicate transmit power output. The proper distance between your mouth and the microphone is 5 cm. If it is too close to the microphone, audio distortion of the transmitted signal may occur.
- The MIC control is used for controlling SSB mic gain. In FM mode, this control is not used. When other stations report your modulation is weak, set the PROC switch to ON. Setting the PROC switch to ON may distort the modulation in FM mode.

■ **SSB OPERATION**

< **Reception procedure** >

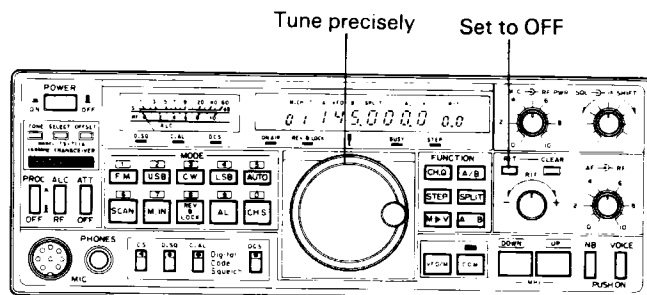

- SSB mode consists of USB and LSB. According to operational custom, USB mode is used in 144 MHz band. Tuning techniques (zero-in) in SSB mode, requires practice.
- The transceiver digital VFO varies 10 kHz per revolution, in 10 Hz steps. Adjust the main tuning control for natural sounding audio in receive.

< **Transmission procedure** >

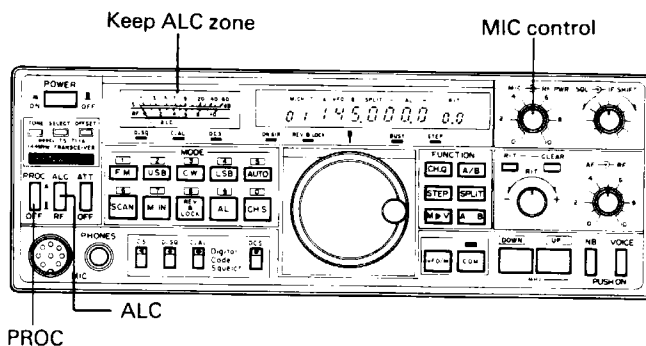

- Set the PROC switch to OFF and ALC switch to ON (for ALC reading).
- Speak in a normal voice with the MIC PTT switch held depressed and observe the meter reading. Adjust the MIC control so that the meter reading remains within the ALC zone.

● **PROC SWITCH OPERATION**

In SSB DX communications, when your signal is insufficiently strong for another station to understand, set the PROC switch to ON to increase talk power. In normal operation, set the PROC switch to OFF.

■ **CW OPERATION**

For CW operation, your transmit frequency should be "zeor-beat" to the transmit frequency of the station you are contacting. This also allows your contact to receive your signal without having to retune his receiver. Tuning methods are detailed in the following paragraphs.

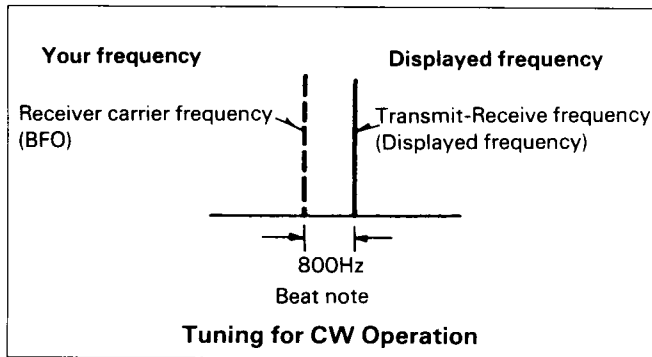

This transceiver utilizes semi break-in CW. Depressing the key sets the transceiver in transmit mode. Semi break-in delay time adjustment can be done with a small (+) screwdriver through the opening on the top cover, as shown.

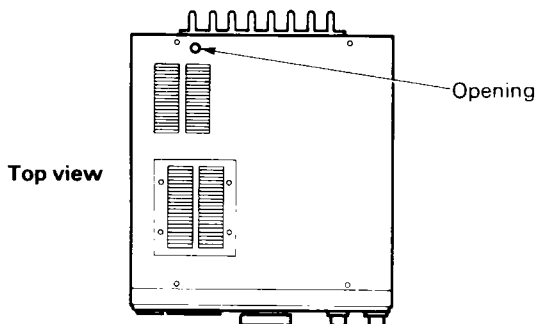

1. Connect a key to the rear panel KEY jack. If the key plug does not match the jack, use an adapter plug or connect the supplied plug.
2. The side-tone circuit is built in, to allow monitoring your CW signal. When in other than CW mode operation, this is used for monitoring your CW keying practice. In this status, transmission is inhibited.
3. Reception in CW is USB. AGC is automatically set to fast.

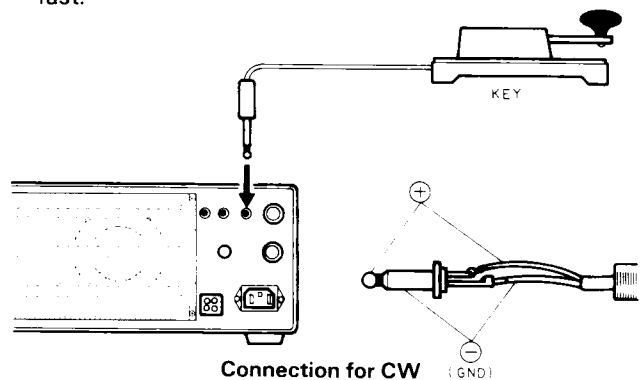

■ **SATELLITE COMMUNICATIONS**

The present Amateur Satellites in orbit are OSCAR 10 and RS 5 ~ 8 (USSR). Communications using these satellites use various frequencies by transponders installed in those satellites. When satellite communication through OSCAR 10 is to be performed using the TS-711A/E and TS-811A/E, proceed as follows. In this operation, use mode B. Perform the uplink on the 430 MHz band (TS-811A/E) and the downlink on the 144 MHz band (TS-711A/E).

<b>OSCAR 10</b>	
Uplink frequency .....	435.025 ~ 435.175 MHz (LSB)
Downlink frequency .....	145.978 ~ 145.828 MHz (USB)
General beacon freq.....	145.810 MHz
Engineering beacon freq....	145.987 MHz

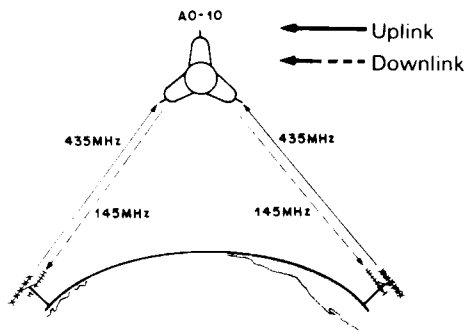

Satellite communications require advanced techniques and skill (orbit information, use of beacon signal, use of antenna, operation behavior, etc.), compared with ordinary communications. Before transmitting, study satellite communications techniques. Several publications are available from organizations such as the ARRL and JARL.

## ■ FUNCTION CONTROLS AND SWITCHES

### ● RIT

RIT (Receiver Incremental Tuning) is a function to only shift receive frequency without changing transmit frequency.

1. The RIT variable range is  $\pm 9.99$  kHz. The two most significant digits are displayed.
2. The RIT allows you to obtain the exact frequency of the other station.
3. Restoring to "0.0" (zero offset) can be done simply, by pressing the CLEAR switch.
4. The RIT works in any mode, COM ch, M ch, or dial locked.
5. The RIT frequency display works even with the RIT switch OFF, and allowing you to preset the RIT.

### ● IF SHIFT

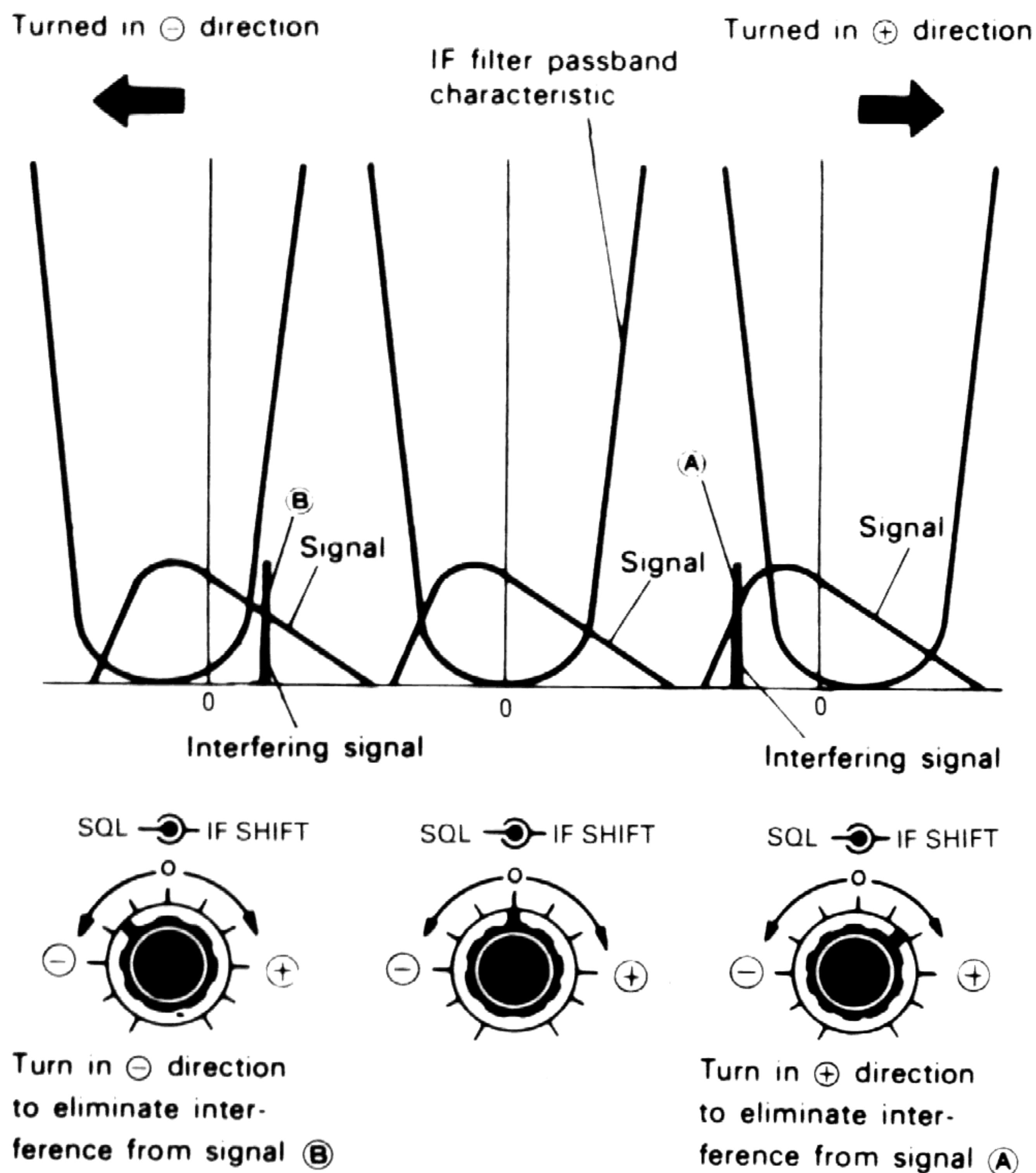

The IF SHIFT control is used to shift the passband of the IF filter without changing receive frequency. By turning this control in either direction, the IF passband is shifted as shown in above figure. The IF SHIFT is effective in eliminating interference when nearby signals are superimposed on the receive signal during either SSB or CW operation. IF SHIFT does not operate in FM mode.

- a) To eliminate interference from signal (B), turn counterclockwise ( $-$ ).
- b) To eliminate interference from signal (A), turn clockwise ( $+$ ).

### ● RF GAIN control

For normal operation, this control should be turned fully clockwise for maximum sensitivity. Receive sensitivity is reduced by turning the control counterclockwise. Adjust the RF control so the S-meter does not show excessive deflection. This minimizes noise during reception and allows the S-meter to indicate signal peak (or a little below that point). Noise is markedly reduced when signal is absent.

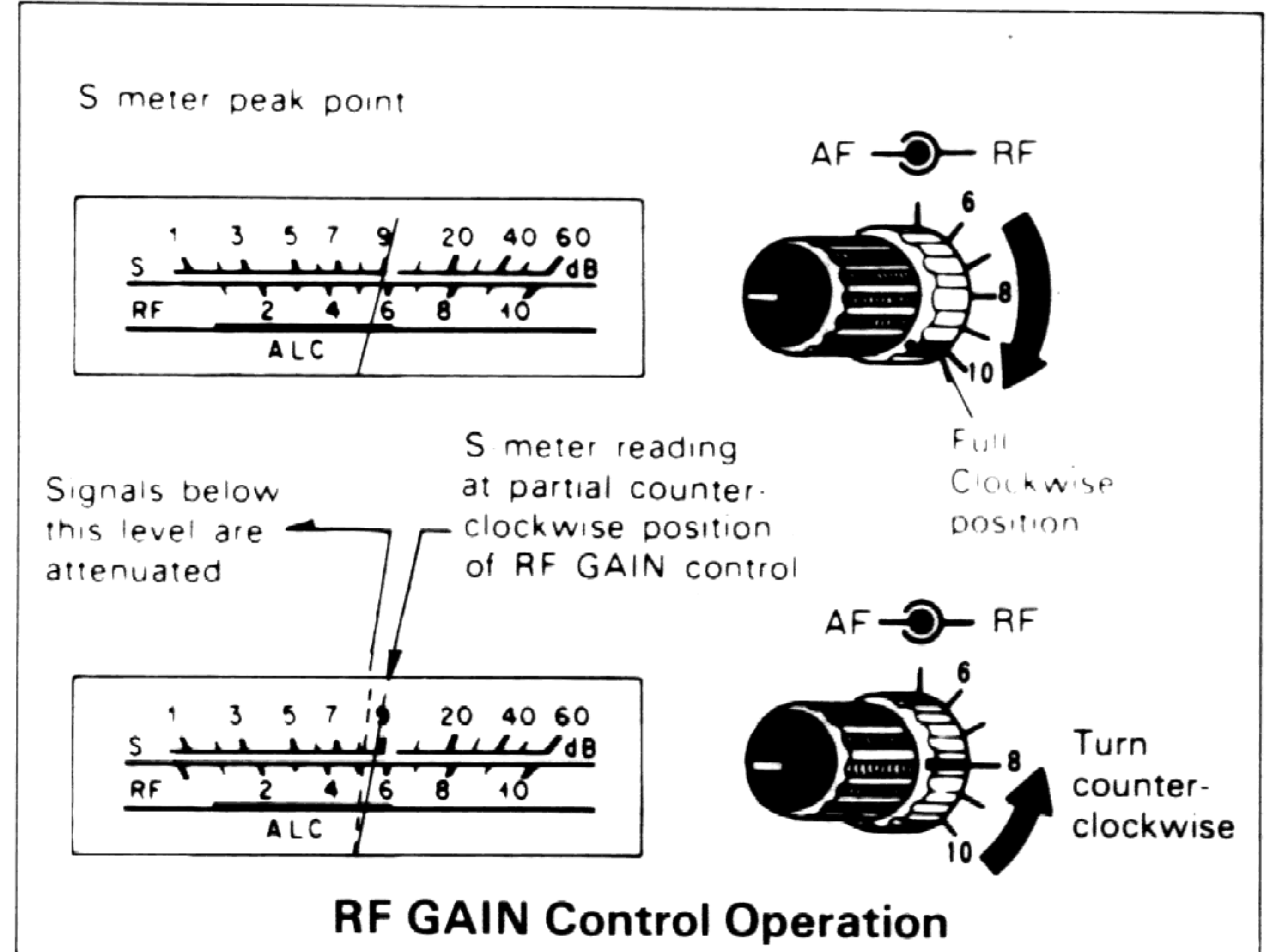

### ● RF PWR control

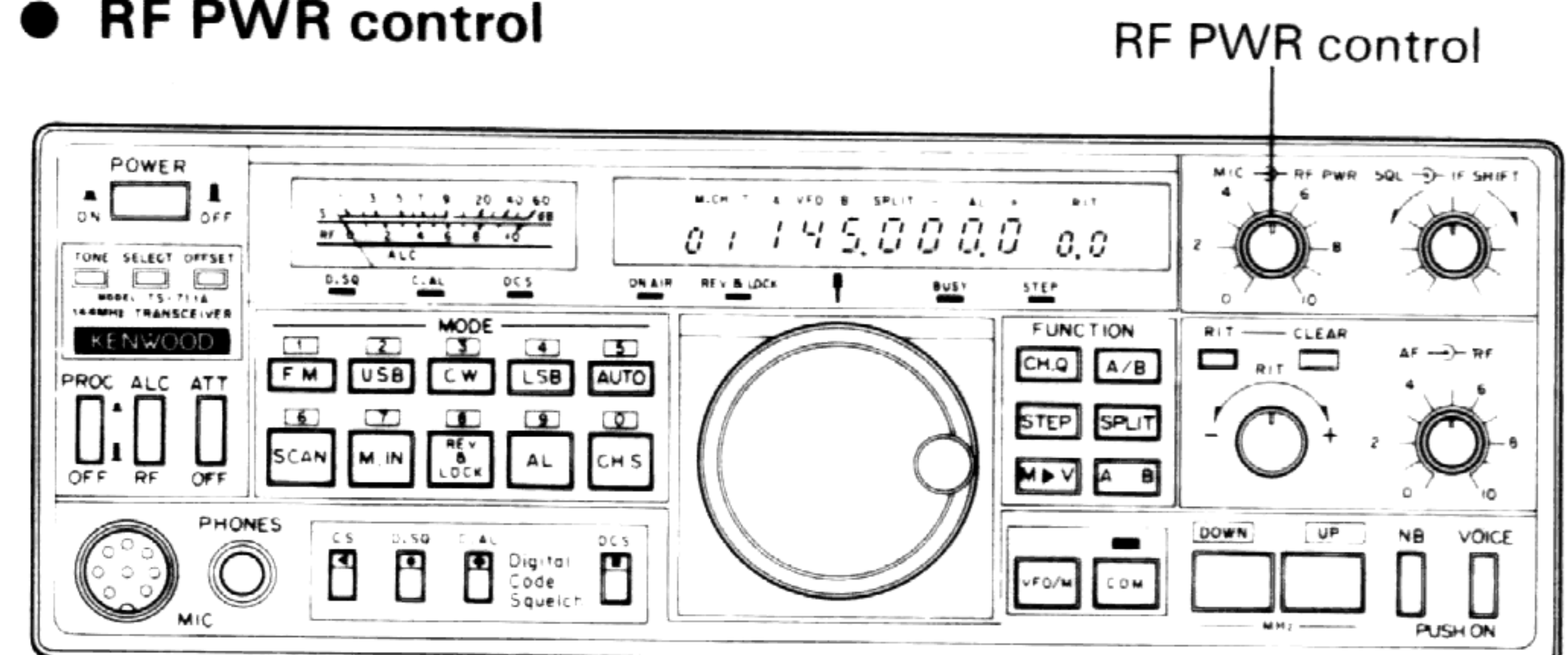

This function continuously varies transmit power output from approx. 2W through the maximum (rated output) in any mode. In QSO is with local stations (relatively near stations), lowering the transmit power output, reduces interference to other stations, and also saves on power consumption. RF 8 of the meter graduation corresponds to the rated output (at 50-ohm load). Meter reading "RF 6" indicates approx. 1/2 the rated output. Minimum RF power output is indicated by meter reading "RF 1 ~ 2".

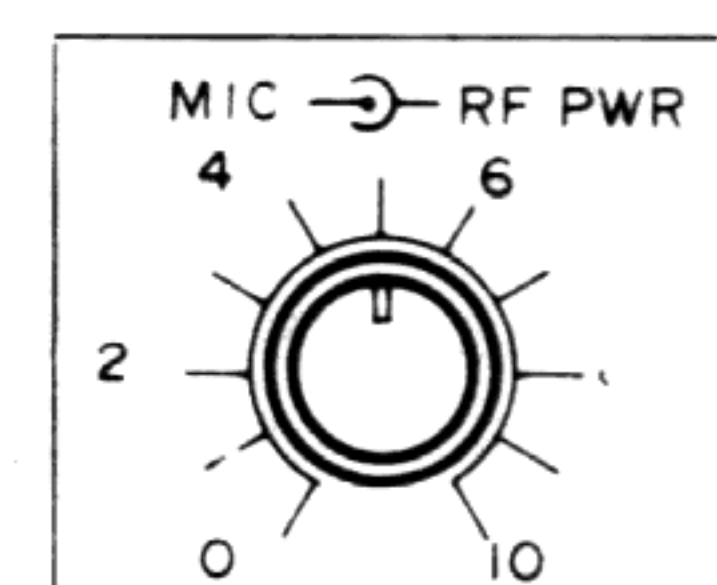
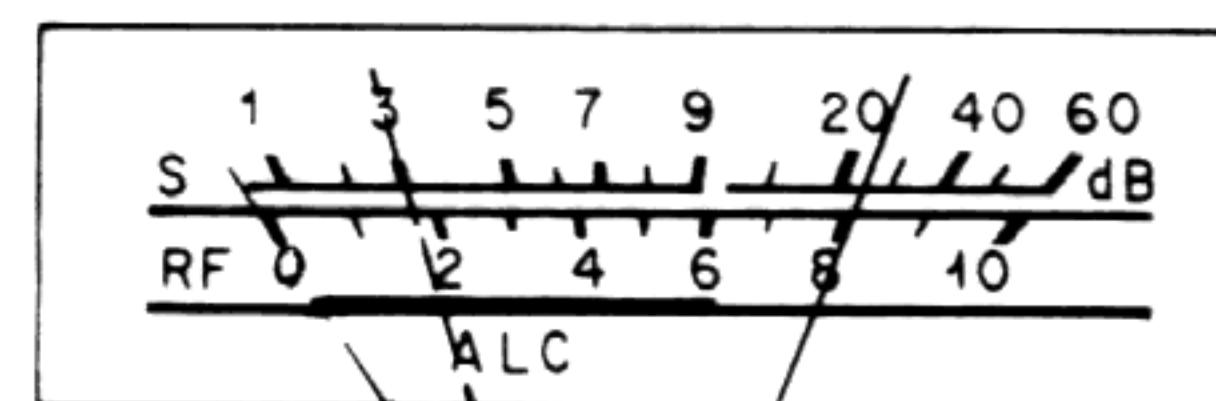

### ● Auto reset thermal protector

This unit is equipped with a thermal protector circuit which prevents part deterioration due to heat caused from continuous transmission. If the PTT switch is left on or the transmission continuous for 40 minutes to 1 hour, the auto reset thermal protector functions to stop operation.

At this time, leave the unit for 10 - 15 minutes to cool it. If your unit is equipped with a cooling fan, keep the fan activated.

## ■ DIGITAL FUNCTION

### ● Memory

There are 40 memory channels.

M1: Frequency; 144.000 MHz, Mode; AUTO CW, and Dial; click are the default values.

M2 ~ M35: Ordinal memory channels.

M36 ~ M38: Split memory channels, i.e., transmit and receive frequencies can be stored individually.

M39 ~ M40: The program scan range is stored in these two channels.

### ● Memory contents

Frequency, mode, main dial status (click or continuously variable), offset, and tone can be stored in each memory channel RIT status cannot be stored.

### ● Memory entry

#### < M.CH >

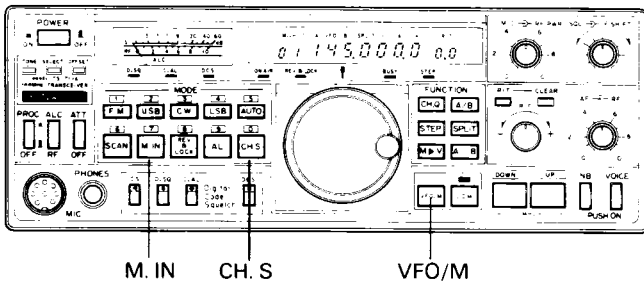

1. In VFO mode, select the data to be memorized with the main dial.
2. Set the CHS switch to ON and select the desired memory channel.
3. Press the M.IN switch, and 8 beeps will sound. Press the M.IN switch again while the beeps are sounding. When memory entry has been performed, the beep sounds again to verify memory storage.
4. Channels M36 through M38, require input of both transmit and receive frequencies. After the RX frequency has been entered the radio will emit a series of 4 beeps. Select the desired transmit frequency and then press the M.IN key. A single beep will sound to confirm entry.

#### < COM >

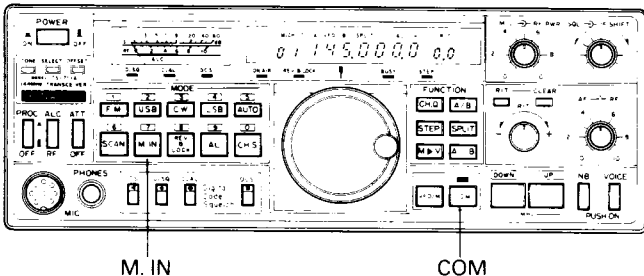

1. In the VFO mode, set the data to be memorized with the main dial.
2. Press the M.IN switch and a double beep will sound and repeat. Press the COM switch while the beep is sounding. A single beep will confirm entry.

#### < M.CH data replacement >

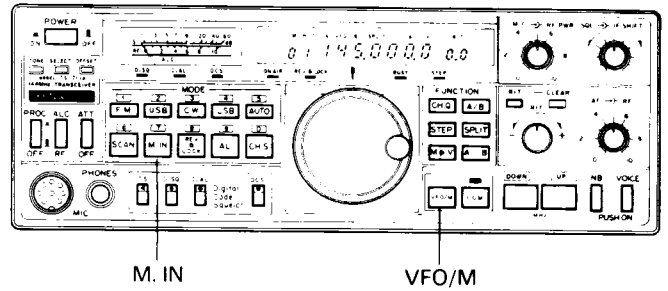

Recall the desired M.CH with the VFO/M switch. If the stored data except frequency fails, reset the required data. Press the M.IN switch and beep will sound. Press the M.IN switch again while the beep is sounding and the replaced data is stored.

### ■ SCAN

The scan modes of this transceiver are:

Program scan in VFO; memory scan in M.CH; and mode scan in M.CH.

### ● Program scan

1. In VFO A or B, when the SCAN switch is set to ON, scan will start within the limits stored in M39 and M40. When VFO is at a point, scan starts as follows.

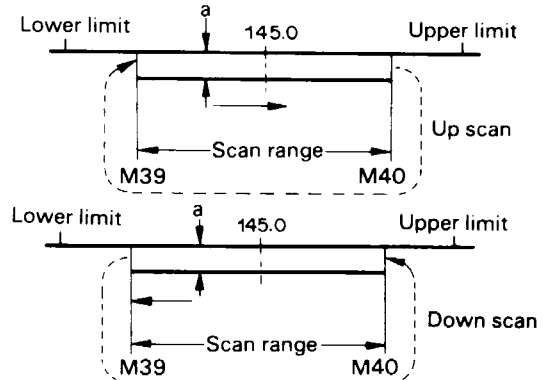

When VFO is at b point, scan starts as follows.

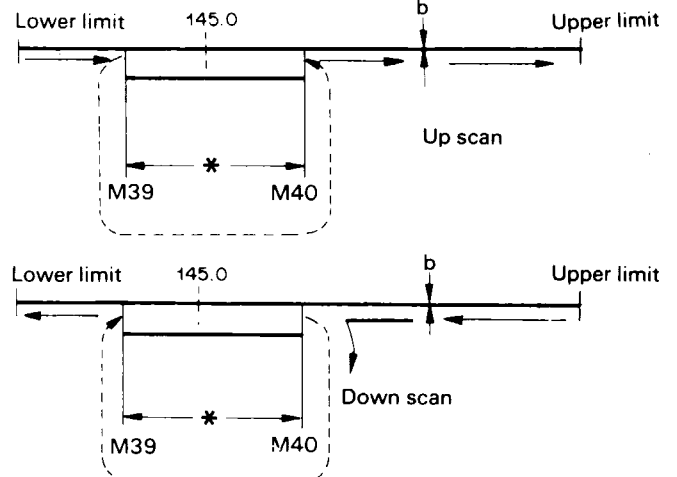

\* The indicated range is not scanned.

2. Scan direction up or down can be reversed by the main dial during scanning.
3. Releasing scan can be done with any key, other than MHz, UP and DOWN.
4. When no data is stored in M39 and M40, scan is performed throughout the entire frequency range.

### ● Memory scan

In M.CH operation, pressing the SCAN switch starts memory scan. Vacant channels will be skipped.

1. Scanning all memory channels  
By pressing the AUTO switch and the SCAN switch, in that order, all memory channels are scanned.
2. Locking out memory channel(s)  
To lock out a memory channel from memory scan, first select the desired channel.  
Pressing the CH.S key will cause the memory lock out indicator (small decimal point to the right of the CH number) to turn on.  
Pressing the CH.S key again will turn off the lockout function.

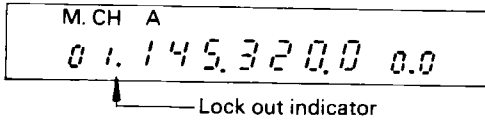

### ● Memory channel mode scan

To scan on the same mode such as FM or CW mode only, first press the AUTO switch so that the AUTO indicator goes off. Next, press the required mode switch and start scan by pressing the SCAN switch. During this operation, locked out channel(s) are skipped.

#### Notes:

1. In FM mode, the center stop function stops scan, at the center frequency.
2. In SSB/CW mode, scan stops if a signal is present.
3. To activate scan, the SQL control should be set at the threshold point.

### ■ ALERT OPERATION

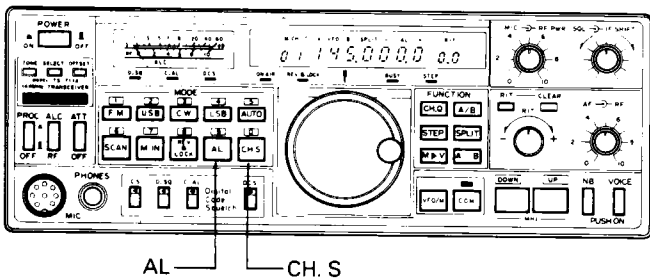

While receiving any frequency with the ALERT switch set to ON, the frequency in M1 can be monitored. When M1 is busy, a double beep will sound.

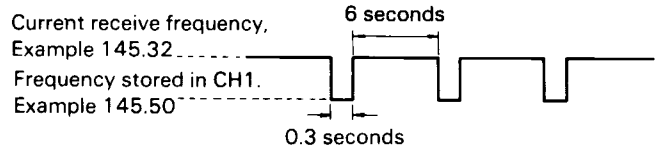

As shown above, M1 is monitored approximately every 6 seconds. However, received audio is muted while M1 is monitored. Note the keyboard functions are locked for the 0.3 seconds of M1 reception.

#### CH.S switch operation with AL switch ON

In M.ch operation – Pressing the CH.S switch ON switches to M1 operation from any memory channel.

In VFO operation – Pressing the CH.S switch ON switches to M1 display from any memory channel display.

### ■ DCS SYSTEM FEATURES

1. Coded squelch operation.
2. 5 digit, ASCII Code variations are possible. Additionally, the TS-711A/E can store 10 different code groups, any of which can be placed in a "standby" or active mode.
3. Automatic transmission of call sign data whenever the DCS system is activated. (ATIS-Automatic Transmitter Identification System).
4. Several methods of signalling the reception of desired stations are available.
5. Microprocessor control minimizes system malfunctions.

### ● Call sign entry

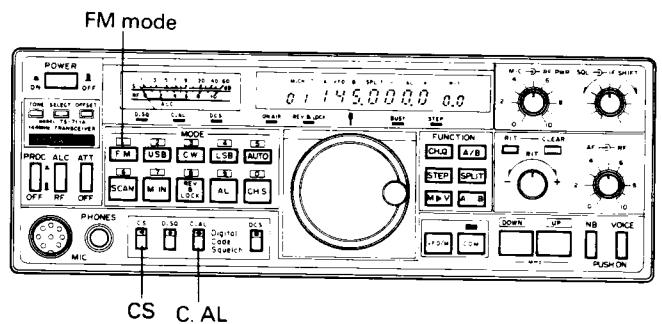



The TS-711A/E employs a method of displaying and entering the call sign 3 digits at a time, using decimal ASCII codes. First encode the callsign into ASCII using the table on page 17.

○ After the call sign has been entered, it will not be necessary to reenter it as long as you operate the TS-711A/B. (However, if the reset switch is depressed, or the lithium battery were to fail reprogramming may be necessary.)

A : 65	K : 75	U : 85	0 : 48
B : 66	L : 76	V : 86	1 : 49
C : 67	M : 77	W : 87	2 : 50
D : 68	N : 78	X : 88	3 : 51
E : 69	O : 79	Y : 89	4 : 52
F : 70	P : 80	Z : 90	5 : 53
G : 71	Q : 81	/ : 47	6 : 54
H : 72	R : 82	Space : 32	7 : 55
I : 73	S : 83		8 : 56
J : 74	T : 84		9 : 57

#### Entry example: WD6DJY

1. With FM mode selected, set the CS switch to ON. Then, the display is:

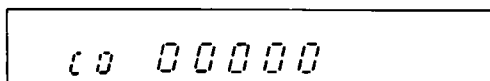

2. Set the C. AL switch to ON. Then, the display shows as follows:

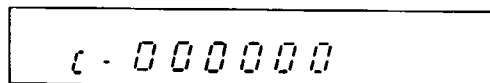

C-: Waits for setting 3 letters from the beginning of the call sign, i.e., W, D and 6. To enter this setting, press keys 8, 7, 6, 8, 5 and 4 in that order.

3. Then, the display will show the following:

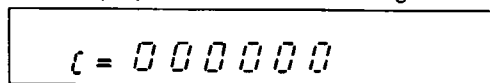

C=: Indicates the radio is waiting for you to enter the last 3 digits. From the example enter 6, 8, 7, 4, 8, 9. After the last digit has been entered a long beep will sound and the display will return to:

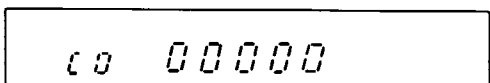

4. Press the C. AL switch twice to verify the data entry.

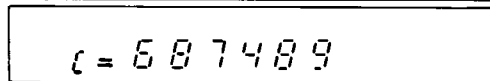
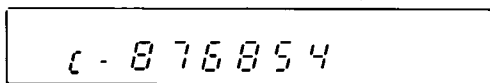

WD6DJY call sign entry is now complete. Now, press the CS switch and the display is restored to the digital code display. Press it again and the display is restored to the normal frequency display.

#### ● Digital code entry

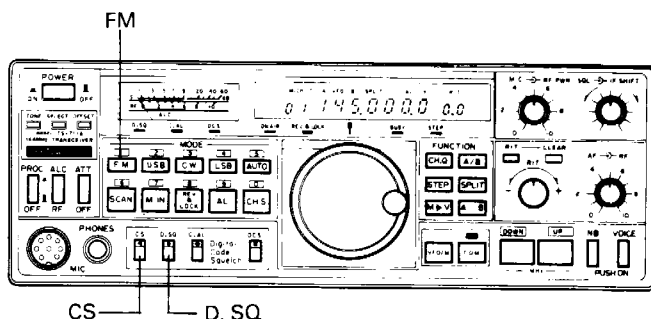

Digital code: Any 5 digit number

This transceiver has 10 (C0 ~ C9) digital code memories. Multiple digital codes can be monitored. However, only one digital code is transmitted at a time.

Entry examples: C0 ..... 12345  
C5 ..... 55667

1. With FM mode selected set the CS switch to ON. Then, the display will show:

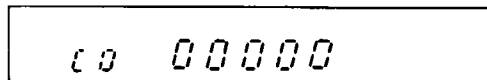

The C0 denotes channel number.

2. Press keys 1, 2, 3, 4 and 5 in that order and a single beep will sound, to confirm completion of data entry. The display will show:

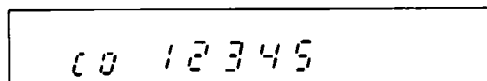

3. Rotate the main dial so that the display is as shown below.

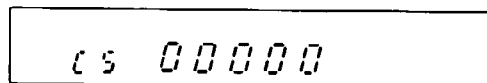

Press keys 5, 5, 6, 6 and 7 in that order. A single beep will sound and the display will show the following:

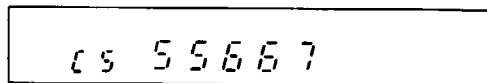

4. Data entry for digital code memory C0 and C5 is now complete. Entry of other channels can be done in the same manner.

#### ● Digital code usage

1. With a code displayed, rotate the Main dial control to display the required code (for transmission).  
2. Press the D. SQ switch to place the standby indicator as shown below.

**Example:**

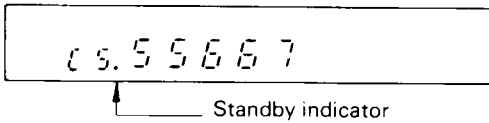

**Note:**

Whenever recalling another memorized code, first erase the standby indicator by pressing the D. SQ switch and repeat steps 1 and 2.

● **Digital code standby**

The "Standby" indicator is a visual indication of which digital access codes will actually open the squelch of the radio. Simply stated it shows the "Active" codes. When the indicator is on the code is active. When the indicator is off, the code is not used.

The digital code displayed when the [CS] key is pressed "ON" (called the transmit digital code) becomes an "active" code regardless of the standby indicator.

However, when using the digital code standby mode, light the standby indicator by pressing [D. SQ] key for the transmission digital code.

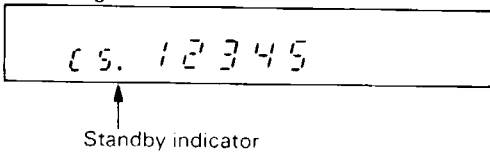

To activate a digital code, select the desired code with the main dial. Then press the [D.SQ] key to turn on the standby indicator. To turn off the indicator press the [D.SQ] key again.

● **After setting digital code**

When the CS switch is pressed, the display indication is as follows:

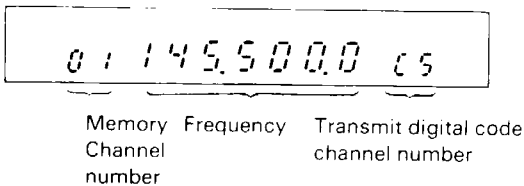

The frequency can be set with the main dial and the transmission digital code channel can be set with CS switch.

● **Digital code squelch operation**

The new DCS system gives the operator the ability to select which stations he wants to listen to. Only those stations that transmit the proper data will be able to "open" the squelch of the TS-711A/E when the DCS system is ON.

You must prearrange which codes will be used, since once you have turned on the system only the proper codes will open the squelch.

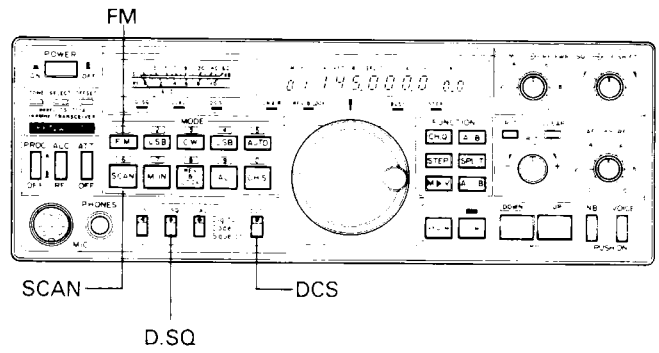

< **Operation** >

1. Press the [DCS] key and then the [D.SQ] key. The DCS system is now active. The DCS and D.SQ indicators will light, and undesired signals will not open squelch.
2. Select the codes you wish the system to recognize by turning on the appropriate standby indicators.
3. When any of the selected codes is received the squelch will open, an alert tone will sound, and the microprocessor will select the proper transmit code to allow normal two-way communications.
4. Two different [DCS] alert signal functions are available.

When the [DCS] and the [D.SQ] keys are on and the proper access code is received, the radio will beep 3 times and the [D.SQ] indicator will turn off.

When the [D.SQ], [C.AL], and [DCS] keys are on and the proper access code is received, the radio will beep 3 times continuously until reset, and the [D.SQ] indicator will turn off.

Use of these alert functions, in conjunction with the optional CD-10 call sign display, will allow unattended monitoring. When you return and discover that the alert function has been activated you can recall the call signs of those stations who have attempted to contact you. Further information on the CD-10 is contained in the operating manual for that accessory.

To reset the DCS system, press the [D.SQ] key, and the [C.AL] key, if desired.

5. The DCS data string takes approximately .2 seconds at the beginning of each transmission. Wait a short period before speaking to allow completion of the data string.
6. Once normal communications have been established turn off the DCS system to avoid this delay.

● **Code scan operation**

1. Press the SCAN switch while [D.SQ] is active.
2. While scanning (memory or program scan), the scan will stop temporarily when a signal is received. If the received signal has the proper digital code, the [D.SQ] indicator will go off, and squelch will open. Scan will be stopped at this frequency.

## ■ FIXED STATION OPERATION

### ● Antenna

Yagi antennas (ARRAY)

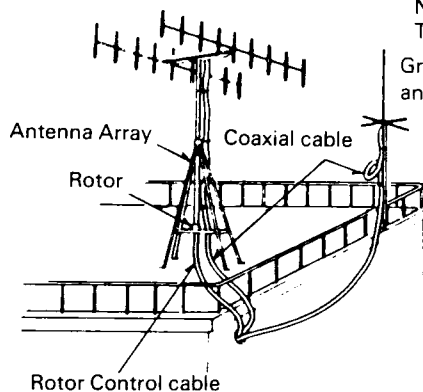

Various types of fixed station antennas are commercially available, select your antenna according to your installation space and application.

Note that the SWR of your antenna should be less than 1.5. A high SWR will cause the TS-711A/E protective circuit to operate, reducing the transmit output power.

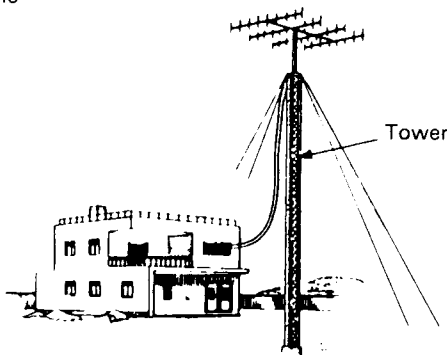

Transceiver performance depends largely on the type of antenna used. For fixed station operation there are ground plane antennas (omni-directional) and Yagi antennas (uni-directional). The Yagi antenna is suitable for long distance operation (DX) or communication with a specific party.

### ● Connections

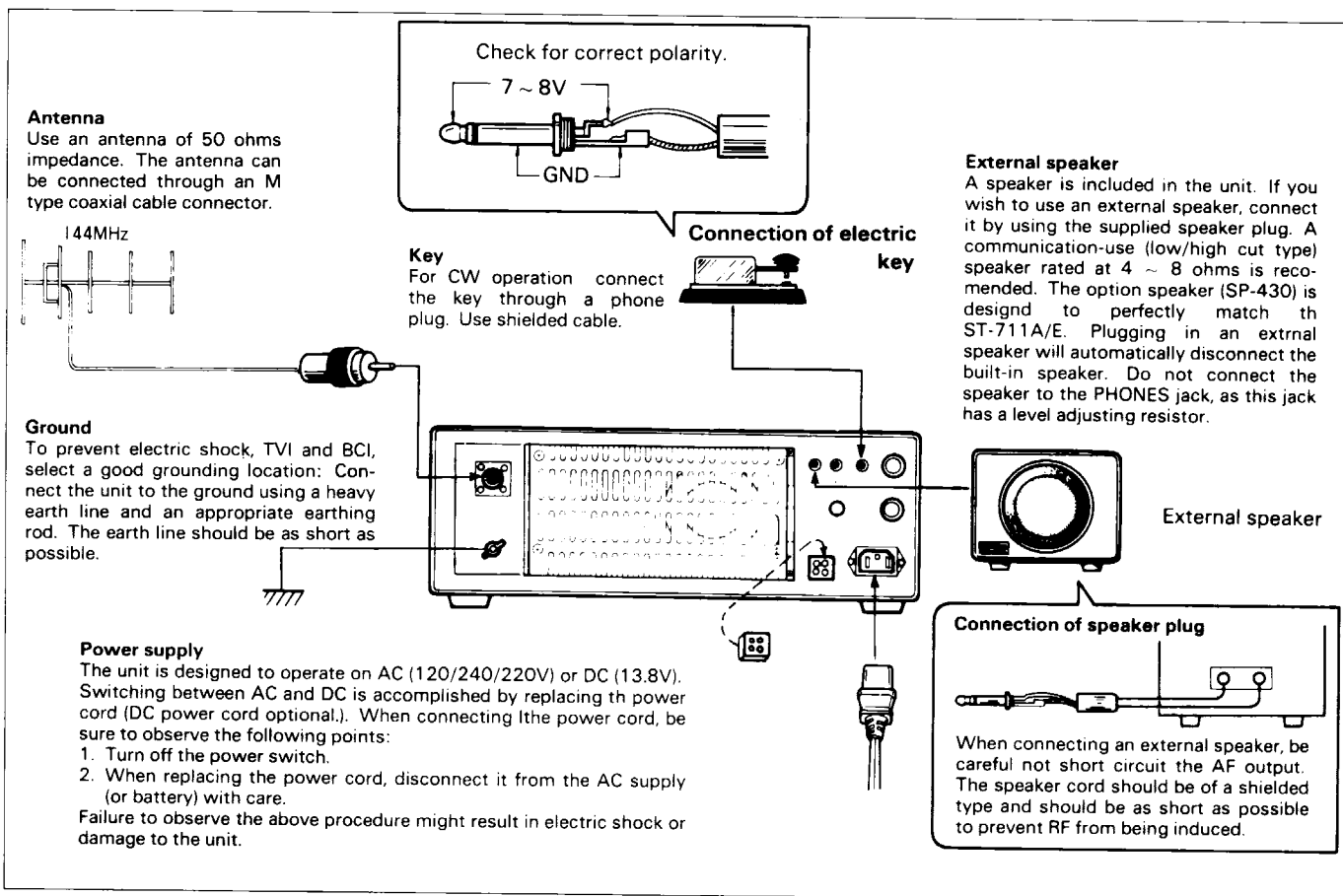

## ■ MOBILE INSTALLATION [GENERAL]

### ● Installation location

Using the optional mounting bracket, install the transceiver under the dashboard in your car. If your car is equipped with electronic fuel injection, the transceiver should be as far from the control equipment as possible.

### ● Antenna installation

Various types of antennas for 2 meters mobile operation are available.

**Note:** \_\_\_\_\_

For gutter-mount installation, the antenna bracket must be grounded to the car body as shown on the following page.

Affix the antenna securely, referring to the antenna instruction.

### ● Power supply

Connect the supplied power cord with fuse directly to the battery terminals. Connecting to the cigarette lighter socket can cause a poor connection, and excessive voltage drop.

### ● Ignition noise

The transceiver is designed to suppress ignition noise; however, if excessive noise is present, it may be necessary to use suppressor spark plugs (with resistors).

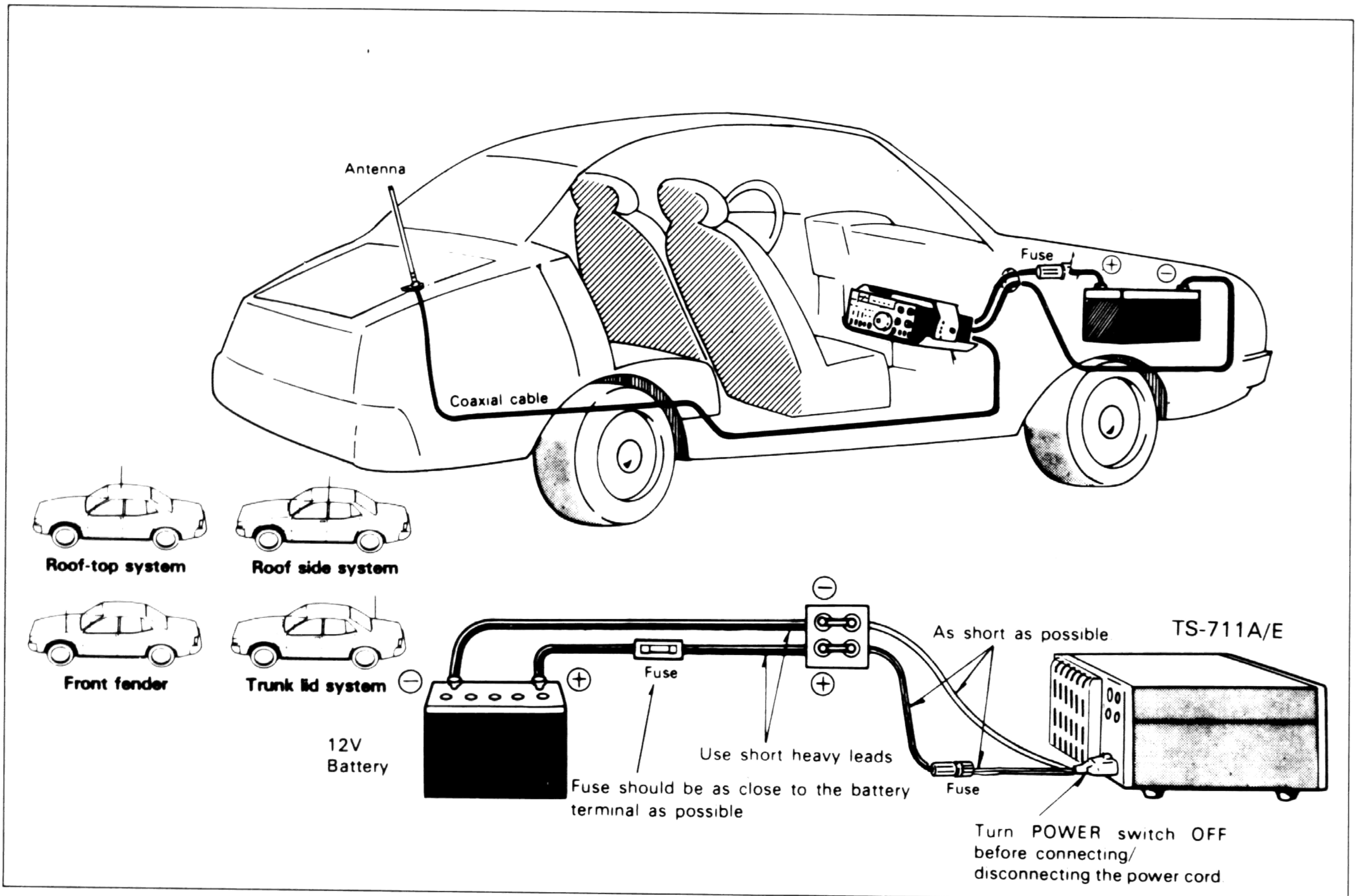

## MAINTENANCE AND ADJUSTMENT

### ■ BEEP SOUND VOLUME ADJUSTMENT

Remove 8 screws from the top cover and remove the cover. By adjusting VR1 (yellow) on the control unit, the required audio volume can be obtained.

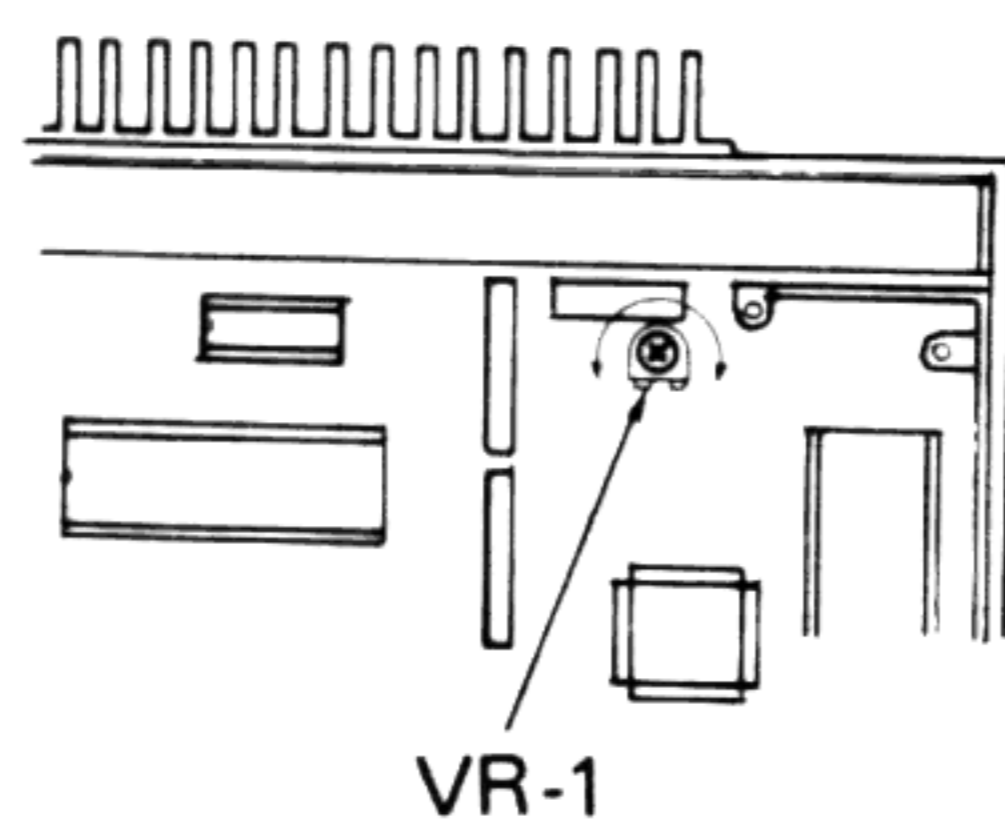

### ■ MAIN DIAL TORQUE ADJUSTMENT

Adjust the torque adjusting screw on the bottom cover with a (-) head screwdriver. Turning the screw clockwise increases drag and counter-clockwise decreases it.

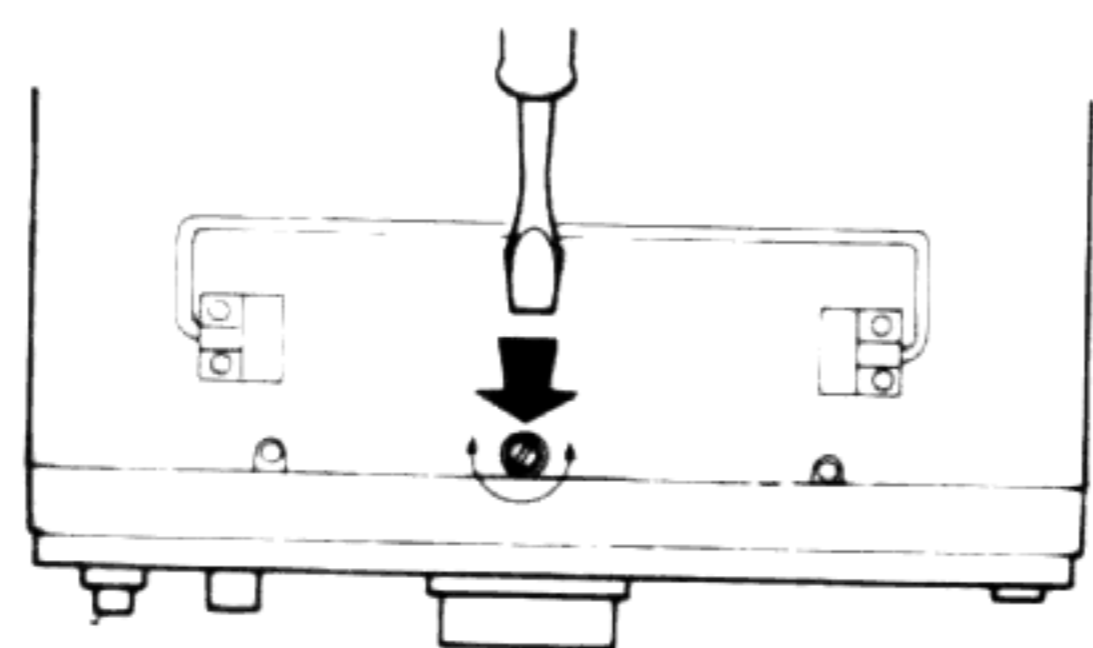

### ■ TO MONITOR YOUR CALL SIGN

When the optional call sign display is connected, your call sign can be monitored when transmitting.

- 1) Remove 8 screws from the transceiver top cover with a (+) screwdriver and remove the cover.
- 2) As shown in the figure below, link the terminals marked Y and X with a jumper wire on the control unit. Use a low wattage pencil type iron.

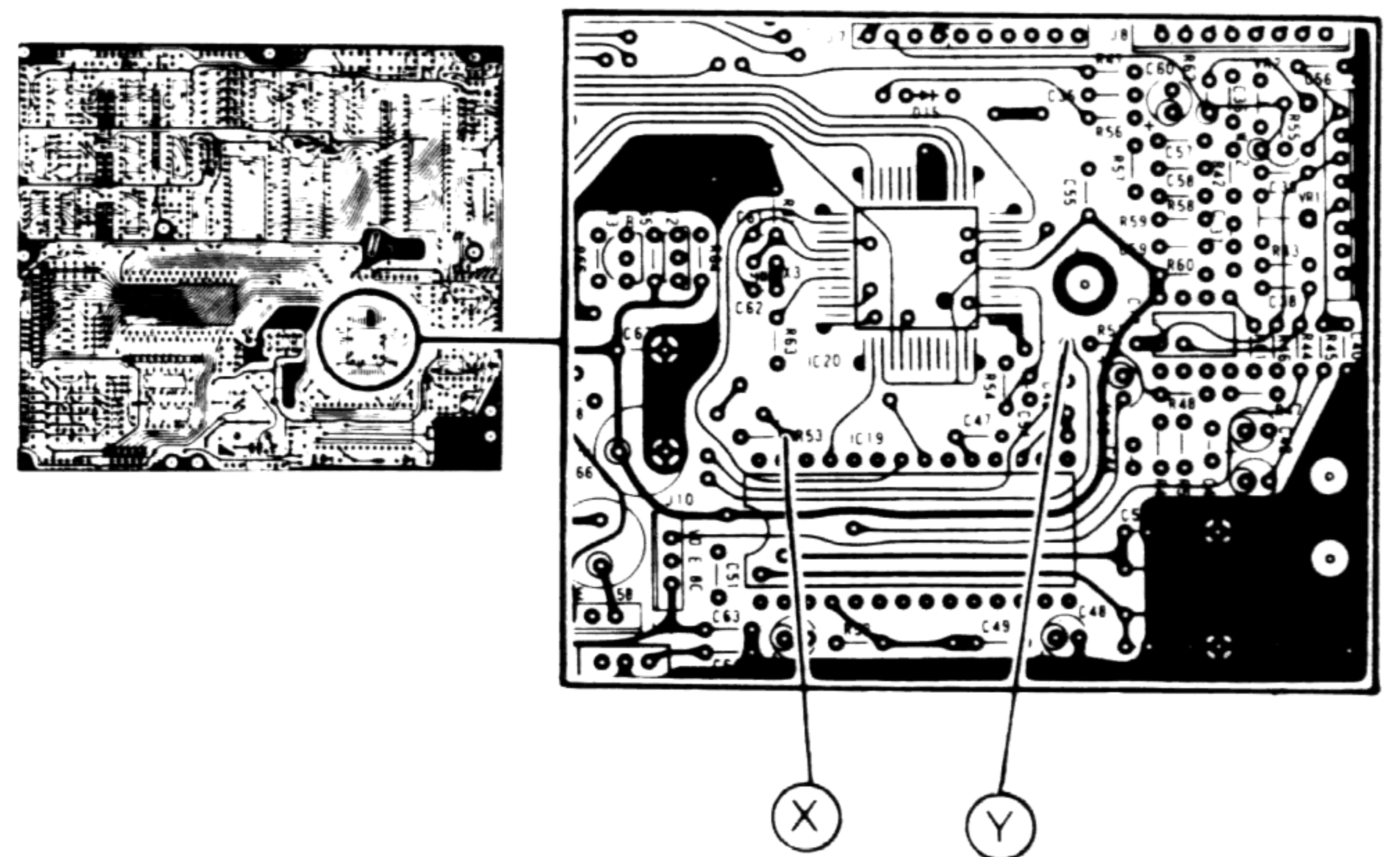

#### Note:

When transmitting with this jumper wire connected, noise may be observed. If so, remove the jumper.

### ■ SIDE TONE VOLUME ADJUSTMENT

1. Remove the TS-711A/E bottom cover.
2. Adjust VR-4 as shown to your preference.
3. Replace the bottom cover.

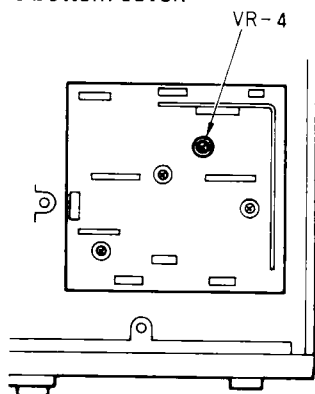

### ■ BACKUP BATTERY REPLACEMENT

A lithium battery is contained in the transceiver to retain memory. Thus, turning off the POWER switch, disconnecting the power cable, or a power failure will not clear the memory. The battery should last approximately five years. Frequent operation of the power ON/OFF switch may lessen the life of the battery. When the battery discharges, an erroneous display may appear on the DISPLAY. Lithium battery replacement should be performed by an authorized Trio-Kenwood service facility, your Trio-Kenwood dealer, or the factory.

#### Note:

When the lithium battery is replaced, the microprocessor must be reset.

### ■ RESETTING

To reset the microprocessor, turn on the POWER switch with the A = B switch held pressed. Removing your finger from the A = B switch completes the reset.

### ■ ACC1 jack

This jack is designed for connection of the 6-pin DIN connector supplied with the optional interface unit.

### ACC2 jack

Terminal numbers and their applications are as follows:



View from the rear panel

Pin No.	Pin Name	Application
1	NC	No connection
2	NC	No connection
3	Data output	Output level is fixed regardless of the AF control setting. Output voltage: 300 mV or more at maximum receiving input with 4.7 kΩ load.
4	GND	Grounding (The shielded wire of the data output terminal is connected here.)
5	NC	No connection
6	NC	No connection
7	NC	No connection
8	GND	Grounding
9	MIC mute	Signal input from the MIC jack is muted. Grounding mutes signal.
10	NC	No connection
11	Data input	Input terminal for data communication. In SSB, MIC gain can be controlled by the MIC control. Input voltage: 500 mV or less (SSB: Voltage starts deflecting ALC. FM: Voltage providing ± 3.0 kHz modulation ratio.)
12	GND	Grounding (The shielded wire of the data input is connected here.)
13	Stand by	Standby terminal Grounding transmits.

ACC2 jack is used for data communications using a computer. When the call sign display CD-10 is used, connect it to the ACC2 3rd terminal.

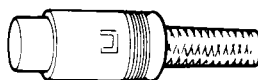

13 pin DIN plug supplied

# TROUBLESHOOTING

The problems described in this table are failures caused in general by improper operation or connection of the transceiver, not by defective components.

There is a separate Service Manual for repair of the Transceiver.

## Transmitter Section

Symptom	Cause	Remedy
No output (SSB).	<ol style="list-style-type: none"> <li>① Poor contact of the MIC-plug.</li> <li>② Mic control set minimum.</li> </ol>	<ol style="list-style-type: none"> <li>① Plug the MIC plug firmly.</li> <li>② Adjust MIC control clockwise.</li> </ol>
In CW mode, no transmission when KEY pressed down.	KEY plug not connected properly. KEY has poor contact point.	Check the KEY plug. Clean KEY contact point.
Pressing PTT switch does not allow transmission.	Due to high temperature transmission prevented by protection.	Set to reception mode and cool enough for transmission.

## Receiver Section

Symptom	Cause	Remedy
No light and no display with POWER switch ON.	<ol style="list-style-type: none"> <li>① Check AC plug connection.</li> <li>② DC short plug not connected.</li> <li>③ Fuse blown.</li> </ol>	<ol style="list-style-type: none"> <li>① Connect firmly.</li> <li>② Connect the plug.</li> <li>③ Replace fuse. If it blows again, check the transceiver.</li> </ol>
Signal not received even the antenna connected.	<ol style="list-style-type: none"> <li>① Squelch activates.</li> <li>② Transmit mode is used.</li> <li>③ ATT switch set to ON to reduce sensitivity.</li> </ol>	<ol style="list-style-type: none"> <li>① Rotate squelch control counterclockwise.</li> <li>② Release PTT switch for reception.</li> <li>③ Set the ATT switch to OFF.</li> </ol>
Signal is not received even the antenna connected. S meter is fully deflected.	RF gain is lowered by RF control.	Rotate the RF control fully clockwise.
An antenna is connected but no signals are heard.	Microphone PTT switch (or stand-by switch) is in the transmit position.	Release the PTT switch.
An antenna is connected but S-meter deflects without a received signal.	<ol style="list-style-type: none"> <li>① RF GAIN control closed.</li> <li>② Low AC line voltage.</li> </ol>	<ol style="list-style-type: none"> <li>① Open RF GAIN control.</li> <li>② Use a step-up transformer to raise the line voltage.</li> </ol>
SSB signal unintelligible.	MODE switch is set to wrong sideband.	Turn MODE switch to the correct sideband.
Current status would not change.	Lock switch set to ON. COM switch set to ON.	Set it to OFF. Press the COM switch again to switch to VFO.
Press the VFO/M switch to set Mch mode, indication disappears.	When memory has no data, the display indicates CH number and .....	Enter necessary data.
Display is dimmed.	AC line voltage is low.	Raise the line voltage up to your local voltage by boost transformer. For DC, use the one 12 – 16V.
DCS does not activate.	Mode other than FM is set.	Set to FM mode.

## ACCESSORIES (OPTION)

### ■ SP-430 EXTERNAL SPEAKER

The SP-430 is an external speaker designed for use with the TS-711A/E. It matches the transceiver in styling and tone quality.

### ■ MB-430 MOBILE MOUNT KIT

Mobile mount designed for the TS-711A/E. It allows easy installation and removal the transceiver.

The MB-430 can either be suspended from the dashboard or attached to the transmission tunnel or a center console. The transceiver tilt angle can be adjusted 5 steps.

### ■ MC-60A

Deluxe Desk-Top Microphone with UP/DOWN Switch (Built-in preamplifier, 8 pin plug)

### ■ MC-80

Desk-Top UP/DOWN Microphone with built-in Pre-Amplifier (8 pin)  
Electret condenser microphone

### ■ VS-1 (VOICE SYNTHESIZER UNIT)

When the voice synthesizer unit is installed in your transceiver, current information can be monitored. By depressing the front panel VOICE switch, the current status can be confirmed, without looking at the transceiver.

#### Mounting procedure:

1. Remove 8 screws from the transceiver top cover with a (+) screwdriver and remove the cover.
2. Connect jumper (A), supplied with the transceiver, as shown.
3. Secure the VS-1 unit on the mounting space with 3 screws supplied.
4. Connect the 3-pin blue plug of lead (A) to the mating jack of the VS-1 unit as shown by the arrow.
5. Connect the 10-pin plug jumper (B), supplied with the transceiver, between the VS-1 unit and the transceiver control unit, as shown.
6. Reverse step 1 to complete the mounting procedure.

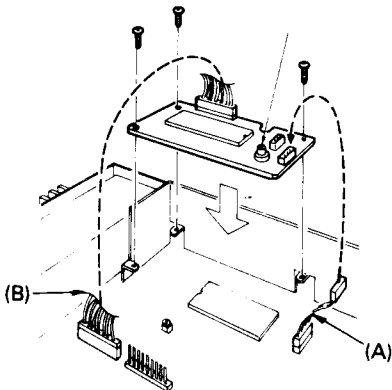

### ■ MC-85

Deluxe Desk-Top UP/DOWN Microphone with built-in Speech Compressor. (8 pin)  
Electret condenser microphone

### ■ MC-42S

UP/DOWN Microphone (8 pin plug)

■ MC-48 TOUCH TONE MICROPHONE (For users in U.S.A. only)

### ■ HS-5 Headphone

### ■ HS-6 Headphone

### ■ CD-10 CALL SIGN DISPLAY

### ■ PG-2J DC CABLE

### ■ TU-5 SUBTONE UNIT (For the TS-711A only)

When the TU-5 is mounted, any sub tone frequency from 67.0 Hz (01 ch) through 250.3 Hz (37 ch) may be selected.

#### Mounting procedure:

Ensure the TS-711A POWER switch is OFF.

1. Remove 8 screws from the TS-711A top cover and remove the top cover.
2. Remove the stand-off screw. The screw will be used to secure the TU-5 tone unit.
3. Align the TU-5 unit as shown in the figure and plug the unit onto the 10-pin connector (J7).
4. Secure the unit on the stand-off with the screw.
5. Reverse step 1) to complete the TU-5 unit mounting.

To select the desired tone frequency, press the SELECT switch to change the tone frequency display.

The desired tone frequency can be selected with the main dial or the mic UP/DOWN switch.

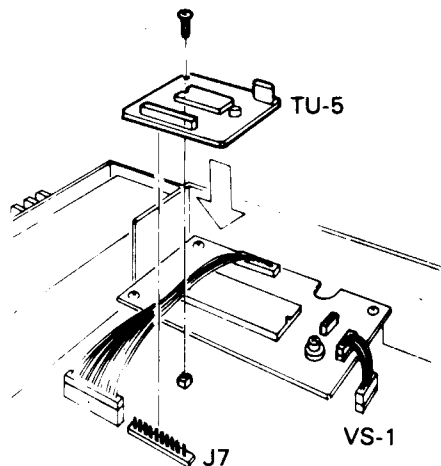



SP-430

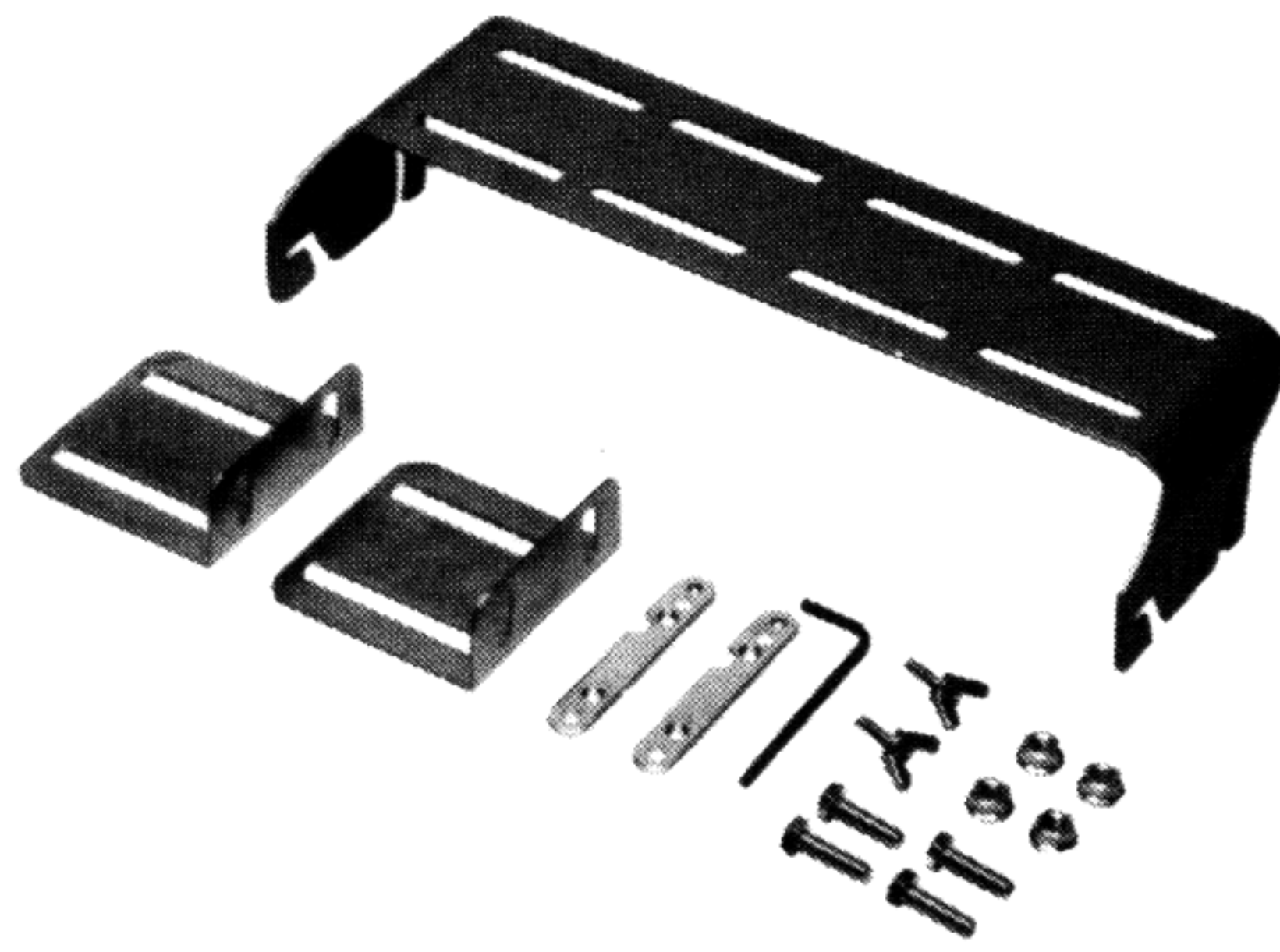

MB-430



MC-60A

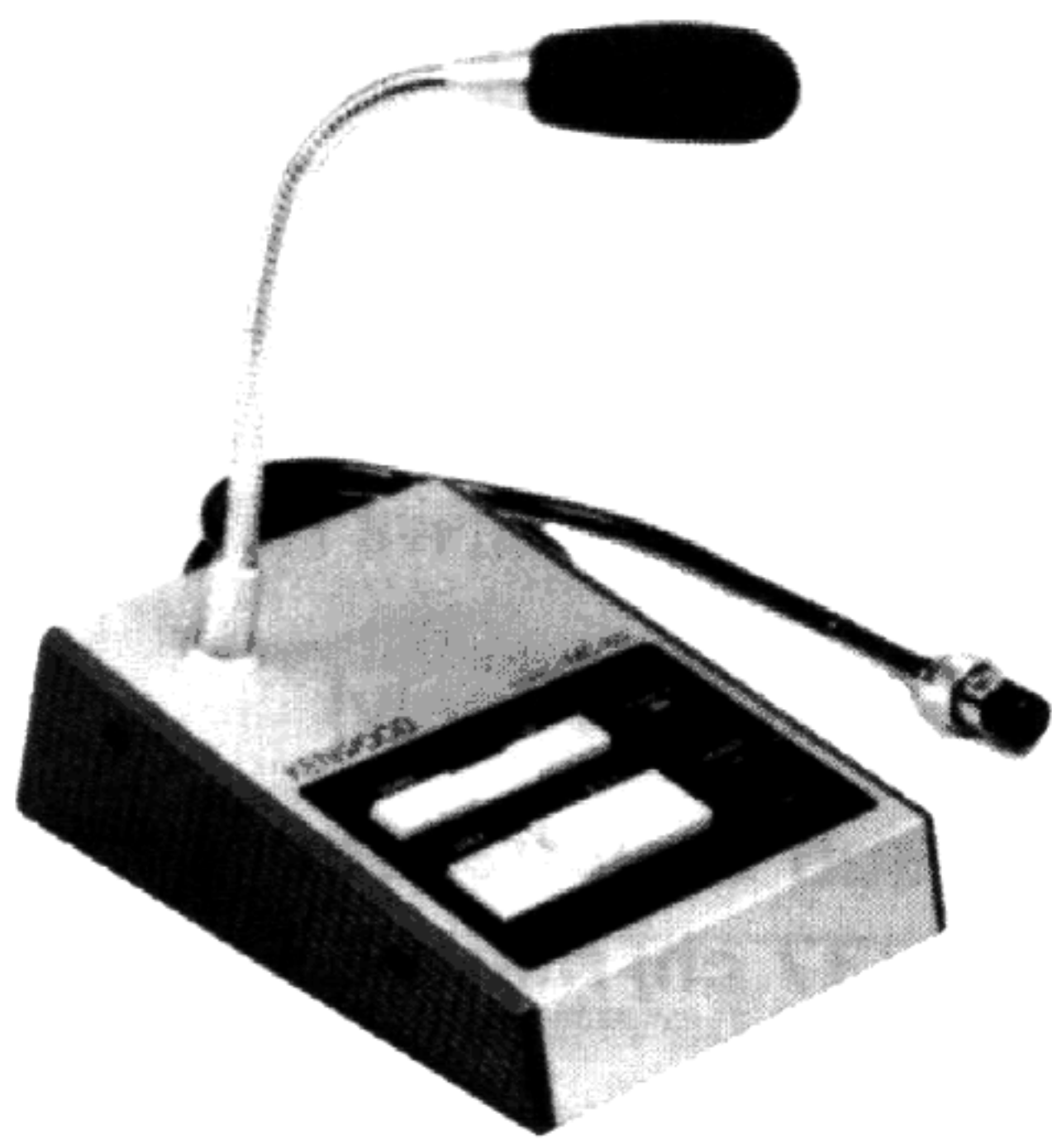

MC-80



MC-85



MC-42



MC-48  
For users in USA only

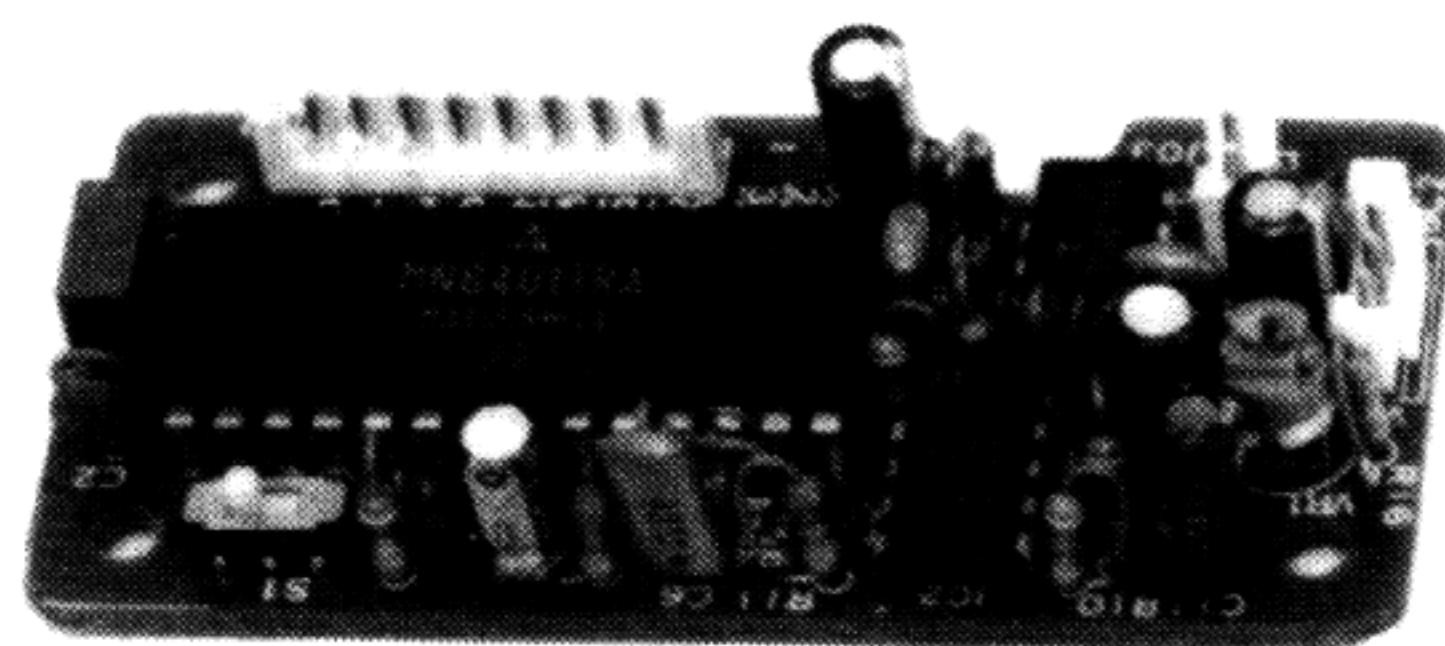

VS-1

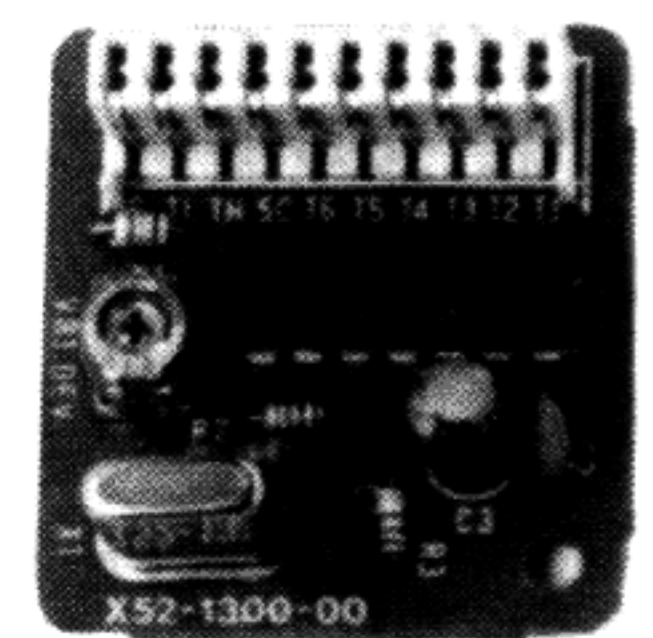

TU-5  
For the TS-711A only



HS-5



HS-6



# CIRCUIT DESCRIPTION

## ■ FREQUENCY CONFIGURATION

Reception uses a double conversion superheterodyne system, in which the second IF (Intermediate Frequency) differs according to the mode. Here, the signal from the antenna is mixed with the PLL, (Phase Locked Loop) local OSC, (Oscillator), signal in the first mixer common to the respective modes and is then converted to the first IF at 30.265 MHz.

At this point, the first IF is separated between SSB/CW and FM modes. In SSB/CW, it is mixed with a 40.96 MHz local OSC signal (4 times the TCXO frequency) in the second mixer (Q34) and is converted to the second IF at 10.695 MHz. Then, this IF is product detected with a 10.6965 MHz carrier. In the FM mode, it is mixed with the 30.72 MHz local OSC signal (3 times the TCXO frequency) in the second mixer (Q36) and is converted to the second IF at 455 kHz.

Then, this IF is detected.

In SSB/CW transmission, the SSB/CW signal 10.695 MHz is mixed with the 40.96 MHz local OSC signal (4 times the TCXO frequency) in the balanced mixer (Q6/Q7) and is converted to a 30.265 MHz signal. It is then mixed with the 113.735 – 117.725 PLL signal to the transmission frequency. In FM, a 13.6533 MHz X'tal OSC signal, used in place of the 40.96 MHz local OSC signal is modulated and multiplied by 3 to a 40.96 MHz local OSC signal.

## ■ RF UNIT (X44-1620-01, 11)

### Reception system

The signal input from the RA terminal enters the RF amplifier (Q1) through the ATT circuit (-20 dB). The RF amplifier uses GaAsFET 3SK129. The input uses a 2-pole helical and the output a 3-pole helical, thus obtaining the desired bandwidth and skirt attenuation.

The input signal is converted in the receiving mixer, Q2: C-MOSFET 3SK122 to the first IF 30.265 MHz. Then, the first IF is converted to the RIF level signal through the 2-stage MCF (Monolithic Crystal Filter) and is output to the IF unit.

### Transmission system

The lower IF signal (30.625 MHz) from the IF unit is mixed with the HET signal in the FET balanced mixer (Q3, Q4: 2SK192A) and converted to the transmission frequency. From this transmission signal, any spurious component is eliminated by the 5-stage VCT (Varactor Tuned) circuit in which the PLL unit CV (Correction Voltage) is used. Further, the transmission signal is amplified up to the drive output level of 0.3W for the output transceiver in amplifier Q6. This output is fed to the final module.

## ■ IF UNIT (X48-1400-00, 11)

### Reception system

The reception system is generally divided into SSB/CW and FM modes.

### 1) SSB/CW mode:

The RIF signal (30.265 MHz) from the RF unit is mixed with the 40.96 MHz output from Q2 at Q34: 3SK73 and is converted to the 10.695 MHz second IF. Then, this signal is amplified via the noise blanker gate circuit and SSB filter L12 by IF amplifiers Q20 – 22: 3SK73 (to which AGC product is applied, and is then mixed with the carrier OSC signal by detector) (D10 – 13: IN60) to obtain a demodulated audio output.

For AGC, the IF output of Q22 is taken through AGC buffer Q24 (2SC2458), Q23 controls the AGC voltage.

### 2) FM mode:

The RIF is input to mixer Q36 (2SC2668) via gate-grounded amplifier Q35 (2SK125). For the local OSC signal, 30.72 MHz is obtained by multiplying the PLL 10.24 MHz reference by 3-times (Q38).

There, the RIF signal is converted to the 455 kHz second IF.

This output is amplified via ceramic filter L31 in the IF amplifiers, consisting of Q44 (TA7302P), Q45 (2SC2668) and Q46 ( $\mu$ PC577H), and is then demodulated by ceramic discriminator L34 (CFY455S).

The demodulated signal is filter separated between the AF pre-amplifier (Q49: 2SC2458) and the squelch noise amplifier Q53 and Q54. The "busy" lamp is controlled by the squelch circuit and the center detection circuit (Q47:  $\mu$ PC4558C). To suppress ignition noise, a "killer" circuit using Q62 is added and is controlled by Q61.

### 3) Noise blanker:

Q41 noise amplifier the second IF output obtained by mixing the 30.265 MHz first IF at Q36. It is switched by Q43. Q37 is a switching circuit to blank PLL reset noise which would otherwise occur every 20 kHz.

### 4) SSB squelch:

This acts as a noise squelch. The SSB squelch release signal, taken from AGC buffer Q24, is input to buffer Q39 through squelch sensitivity pot VR6. This output is mixed with 10.24 MHz in the SSB squelch mixer Q40 and converted to 455 kHz. This signal is then input to the FM IF amplifier. Thereafter, the FM squelch circuit is used to provide SSB squelch.

In the SSB mode, Q56 in the squelch circuit operates to set the attack and slow release.

### Transmission system

#### 1) SSB and CW mode:

The audio signal from the AF unit is amplified in the microphone amplifier Q28 – 30 and sent to the balanced modulator, D16 (ND487C1 – 3R). In CW mode, the modulator is unbalanced by DC, and this carrier signal output from the modulator is used. The double side-band output is filtered by 3SK73 (GR) (SSB X'tal filter L12) amplified by FET Q5: and mixed with the 40.96 MHz output from Q2 in balanced mixer Q6, Q7: 2SK161 (GR) for conversion by the TIF (transmit IF) sig-

nal at 30.265 MHz. Then, the TIF signal is amplified by FET Q8: 3SK73 and sent to the RF unit. In CW mode, keying controlled by Q32 and Q8 gate biases using -6V and Q13 switching.

## 2) FM mode:

The carrier signal output from the unbalanced SSB modulator is used. Different from the SSB/CW mode is that the local OSC signal used in FM for balanced mixers Q6, Q7 is oscillated by X'tal OSC L4. This OSC output is tripled 40.96 MHz. In the FM mode,  $\pm 5$  kHz frequency deviation is obtained after tripling the direct modulated X'tal OSC output.

## 3) Power control

The final output is detected, and the ALC (Automatic Level Control) voltage is controlled by Q4 in the Display unit (X54-1820-00). The ALC voltage is applied to the second gates of FETs Q5 and Q8, by which the TIF level is adjusted and then APC (Automatic Power Control) is applied. In addition, the power control, in which two pots are used, controls the G2 voltage of generator buffer Q32, to counter excessive ALC at low power.

## ■ AF UNIT (X49-1180-00)

### ● Microphone amplifier

The signal from the microphone is amplified by Q1 (2SC2459 (GR)), which is common to both FM and SSB modes. In FM mode, the signal is subject to 6 DB/oct pre-emphasis by Q4 (1/2) (NJM4558S) and is amplified by OP amplifier Q4 (2/2). Then, it is high-cut by active LPF (Low Pass Filter) Q9 for -24 dB/oct via amplitude limiter D8 (MC911) and applied as modulation to the X'tal OSC in the IF unit.

In the SSB mode, the output from amplifier Q1 is impedance-converted by emitter-follower Q3 (2SC2458 (Y)) and provided as modulation for the balanced modulator in the IF unit through the microphone gain control on the front panel.

The input signal to pin AN1 of accessory terminal ACC2, in the SSB/CW mode is mixed with the output of microphone amplifier Q3 and is then input to the microphone gain control. In the mode, it is input to amplifier Q4, but not through the pre-emphasis circuit.

Further, Q2 is controlled by the signal input of ACC2 pin MM to turn OFF amplifier Q1 for microphone muting.

### ● Processor

When the processor SW is ON, the processor circuit consisting of Q5, Q6 and Q7 is connected through transistor switch Q8. Q5 is an amplifier circuit with ALC. The NFB (Negative Feed Back) signal from Q5 pin 3 is amplified by Q7, detected by D5 and input for ALC at pin 6. Then, the input is controlled by ALC output pin 5. Q6, an FET switch, adjusts the SSB level to that which has been previously adjusted in the FM mode.

### ● Other circuits

Q11 is the AF PA. Transistor Q10 is an AF amplifier through which the signal is supplied to ACC2. Q12 is the CW side-tone OSC circuit. Q13 - Q16 forms the CW semi-break-in circuit.

## ■ FINAL UNIT (X45-1380-11)

The drive signal from the RF unit is amplified up to 25W by hybrid Q1: M57727.

It is then supplied to the antenna through the ANT switch and the LPF for removal of harmonic component content.

In addition, ALC detection, RF meter, reflected power detection and fan temperature detection circuits are provided. The RF meter circuit is a peakholding circuit in which voltage doubler detection is used. The final PA hybrid is protected in two ways. Reflected power VSWR is detected the antenna circuit and lowers the drive voltage by control of the ALC reference voltage to prevent damage to the final PA hybrid. For the second protection circuit, thermistor TH1 detects the final temperature to control the fan and, prevent abnormal heating in the final unit PA.

## ■ AVR UNIT (X43-1490-11)

The AVR (Automatic Voltage Regulator) unit consists of the rectifier and filter section and the AVR circuit section.

The AVR circuit section has 13.8V, 8V and 9V AVR circuits and a temperature protection circuit and a fan drive circuit.

The 13.8V AVR circuit consists of Q1 - Q4 and pass transistor, Q5. Transistor Q1, which controls Q5 emitter, supplies power (pin BB) which is separately rectified and filtered.

The fan is switched by comparator Q10 (1/2) and Q11 after heat detection by thermistor TH1 in the Final unit.

The temperature protection circuit functions to stop transmission if the transformer heats abnormally due to excessive continuous transmission, etc. during AC operation.

The detection circuit, like the fan, turns OFF the AVR 9T. (9V, transmit) output.

## ■ PLL UNIT (X50-1990-00, 11)

The PLL unit has a double loop configuration an output in 10 Hz steps and uses a 10.24 MHz TCXO (Temperature Compensated Crystal Oscillator) ( $\pm 3$  ppm) as the reference OSC. 10 Hz step operation is achieved by dividing the output of the 2 kHz comparison PLL (Loop B) by a 1/200 divider.

Digital tuning in 10 Hz steps is obtained by mixing that division signal with the output of the 20 kHz comparison PLL (Loop A).

In addition, the carrier OSC, which is located in the PLL unit is configured to form and IF shift.

Loop B is a mixing type PLL. The VCO output operates from 64 - 68 MHz (Q28: 2SK192A in Loop B and is mixed in Q31 (SN16931P) with a 51.2 MHz signal. This reference signal is derived by multiplying 10.24 MHz 5-times, in Q32 (2SC2668) via buffer amplifier Q29

(2SC2668) and then converting to 12.8 – 16.8 MHz. Then, the resultant signal is amplified in Q30 (TA7302) and divided at a frequency division coefficient of from 6400 – 8400 so that a 2 kHz output is obtained. Further, 10.24 MHz is also divided by 1/10 at Q36 and again divided by 1/5, and the resultant signal is phase compared with the 2 kHz reference signal at Q21 (MC145155P).

The PD (Phase Detector) output is converted to a DC loop correction voltage by a 3 transistor stage LPF (Q25 – 27: 2SC2459) to control the VCO (Q28).

Additionally, part of the 64 – 68 MHz VCO output which passed through buffer amplifier Q29 is subject to 1/200 division by divider IC Q23: M54459L for 1/100 division and Q22: SN74LS90N for 1/2 division through buffer Q24 (2SC260 (Y, O)). The output of Q22, therefore, becomes 320 – 340 kHz at a 10 kHz step rate. This output and the output of the carrier OSC are input to mixer Q6 (SN16913P). A 11.025 MHz output is taken through a ceramic filter and a buffer (Q5: 2SC2668). Then, this 11.025 MHz output is mixed at Q4 (SN16913P) with a 20.48 MHz signal which is obtained by multiplying 10.24 MHz by two at Q40 (2SC2668) so that an output of 31.505 MHz is obtained.

Then, this 31.505 MHz output is input to mixer Q3 (SN16913P) as the loop A local OSC signal.

Loop A is a dual modulus type PLL with a 20 kHz comparison frequency. Prescaler Q20 ( $\mu$ PB555) operates at either a 1/16 or 1/17 division ratio. The VCO output (113.735 – 117.735 MHz) (Q10: 2SK192A) in loop A is separated into the HET (Heterodyne) output and the input to mixer Q3 (SN16913P) through buffer Q11 (2SC2668). Mixer Q3 output (80 – 90 MHz) is amplified in a 2 transistor stage amplifier (Q17, 18: 2SC2668) through a 80 – 95 MHz BPF and is input to prescaler Q20.

The prescaler, connected with PLL IC Q19, forms a swallow counter to divide this input at a frequency division coefficient  $NA = 4112$  to  $4312$ . This signal is phase-compared with the 20 kHz reference signal obtained by dividing 10.24 MHz by two and 1/256 division of 5.12 MHz. The output is DC converted by a 3 transistor LPF stage (Q12, 13, 14) to control the VCO (Q10). HET output is obtained by amplifying the VCO output (Q10) by transistor Q1 (2SC2668).

#### Comparison frequency derivation:

[Loop A:]

The 10.24 MHz TCXO output is amplified by two transistor stages (Q34, 35: 2SC2458) via buffers (Q33, 38: 2SC2458), is divided by 1/2 (Q36/2) 5.12 MHz, which in turn is input to PLL IC Q19. This input is divided 1/256 by the divider inside Q19 20 kHz, which is the comparison frequency.

[Loop B:]

The 5.12 MHz output in loop A is further divided 1/5 by divider Q36/2 to 1.024 MHz. This signal is then input to PLL IC Q21 and is divided 1/512 by the divider contained inside Q21 to 2 kHz, which is the comparison signal.

For unlock detection, the output of PLL IC Q19 pin 9 in

loop A is used. The power supply to buffer Q1 is switched by transistors Q15 and Q16.

The carrier X'tal OSC is switched by diode switches D4 and D5. The bias voltage for D4 is applied from the 8C (8V DC common supply) line, and is independent of the mode. However, in the LSB mode, D4 and D5 can be selected by the ratios of R37/R38 and R40/R39.

## ■ CONTROL UNIT (X53-1410-11, 21, 51, 61)

### 1) Basic configuration

The microprocessor, which has an 8-bit (ROM, 6-Kbyte) main CPU (IC24:  $\mu$ PD78026-087-36) and a 4-bit (ROM, 2-Kbyte) sub CPU (IC20:  $\mu$ PD7507G-575-00), uses a CMOS RAM (IC14: MB8418-20LP-GRA) with a capacity of 8 bits x 2K bytes as the external memory IC, the I/O interface IC (IC16:  $\mu$ PD8255AC-5) for I/O port extension and three 6-bit D-flip-flop ICs (IC12, 17, 22: 74LS174). In addition, it is provided with a 24-pin IC socket for the external ROM for optional personal computer interface.

These ICs, connected in parallel with the data bus in the main CPU, exchange data with the main CPU synchronized by timing signals WR or RD of the main CPU, or CS signal from IC15. IC15, a 3 to 8 bit line decoder, decodes inputs to address lines PE13 – 15 in the main CPU to generate the chip select signal (CS). In addition, IC13 takes an OR logic between signals CS and WR to supply the clock pulse to IC12, IC17 and IC22, all of which are used as latches.

The main CPU controls the frequency, mode, offset, tone, display, memory, dial click mechanism, DCS system, voice synthesis, etc. and accepts interface with the sub CPU or an external personal computers.

The sub CPU interfaces with the main CPU or the MODEM IC, IC19, to handle digital signal code conversion and control tone ON/OFF and other such operation.

### 2) DCS system control section

The processing of the digital control signal used in the DCS system is performed by the sub CPU, the MODEM process IC (IC19: MN6127A) and IC18 ( $\mu$ PC4558C).

In transmission, first, the data (digital code, call sign) for the control signal is transferred to the sub CPU from the main CPU. In the sub CPU, logic transforms that data to NRZ (None Return to Zero) code, which is then output to IC19. It is subject to MSK (Minimum Shift Keying) modulation at IC19. Subsequently, that output is input to Q4 in the AF unit via pin ANI and is applied as FM modulation.

In reception, the signal which was subject to FM detection at discriminator L34 in the IF unit is input to IC18 from pin RT. IC18, an active filter, cuts off the high frequency component of this signal and also amplifies it up to the proper input level for IC19, and it is then output to IC19.

At IC19, it is subject to MSK demodulation to NRZ code and is output to the sub CPU, in which it receives the reverse logic operation to that in transmission and is transferred to the main CPU.

# BLOCK DIAGRAM

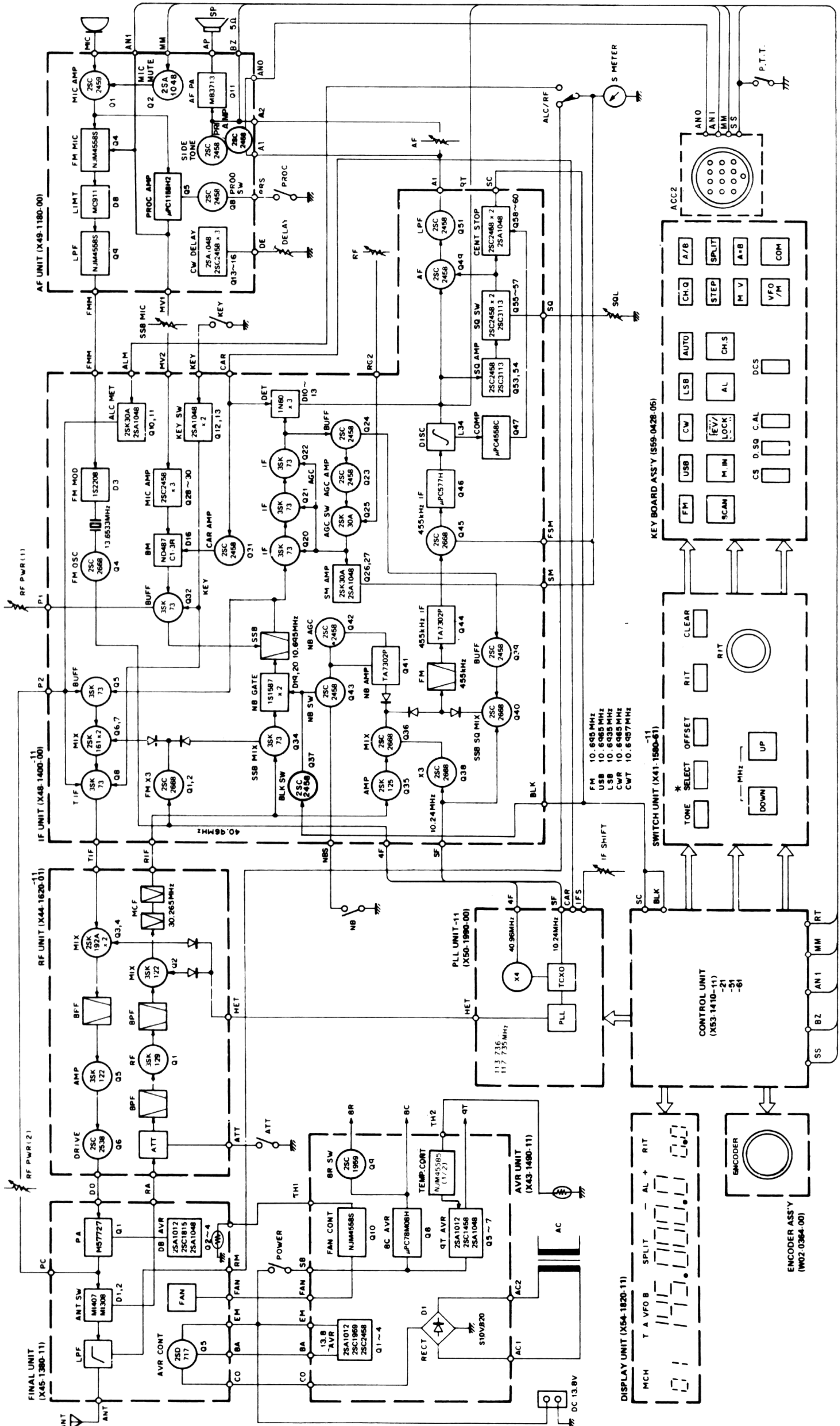

# PLL SCHEMATIC DIAGRAM

PLL UNIT (X50-1990-XX) (-00) TS-7II, W -01) TS-8II, M, J, W, X -11) TS-7II, K, M, J, M, 2, X -12) TS-8II, K



	A	B	C	D	E	F	G	H	I	J	K	L	M	N	O	P	Q	R	S	T	U	V	W	X	Y	Z
TS-711	K, M1, M2, X	X	2ZP	X	7P	O	10P	0.5P	O	X	O	X	X	X	X	X	X	X	X	X	X	X	X	X	X	X
TS-811	M, J, W, X	X	O	5P	X	7P	X	2ZP	0.5P	X	O	X	X	X	X	X	X	X	X	X	X	X	X	X	X	

O - Used, X - Not used

- Q1, 5, 11, 17, 18, 29, 40 : 2SC2668(Y)
- Q2 : 3SK73(Y)
- Q3, 4, 6, 31 : SN16913P
- Q7, 8, 41 : 2SC2787(L)
- Q9, 16, 33~35, 38, 39 : 2SC2458(Y)
- Q10, 28, : 2SK192A(GR)N
- Q12~14, 25~27 : 2SC2459(BL)
- Q15 : 2SA1048(Y)
- Q19 : MC145156P
- Q20 : μP8555C
- Q21 : MC145155P K
- Q22, 36 : HD74LS90P
- Q23 : M54459L
- Q24, 32 : 2SC2668(Y, O)
- Q30 : TAT7502P
- Q37 : NJM78L05A
- D1~3 : 1SV50
- D4, 5 : MA856
- D6~8 : MC921

**Model** TS-711A/E

**Serial No.** \_\_\_\_\_

**Date of Purchase** \_\_\_\_\_

**Dealer** \_\_\_\_\_

\_\_\_\_\_

\_\_\_\_\_

## KENWOOD CORPORATION

Shionogi Shibuya Building, 17-5 2-chome Shibuya, Shibuya-ku, Tokyo 150 Japan

**KENWOOD U.S.A. CORPORATION**

2201 E. Dominguez Street, Long Beach, California 90810 U.S.A.

**KENWOOD ELECTRONICS DEUTSCHLAND GMBH**

Rembrücker Str. 15, 6056 Heusenstamm, West Germany

**KENWOOD ELECTRONICS BENELUX N.V.**

Mechelsesteenweg 418 B-1930 Zaventem, Belgium

**KENWOOD ELECTRONICS AUSTRALIA PTY. LTD.**

(INCORPORATED IN N.S.W.)

4E, Woodcock Place, Lane Cove, N.S.W. 2066 Australia